

CLIPSAL[®]

by Schneider Electric

C-Bus[®] multi-room audio system



- Built-in dual AM/FM tuners •*
- MP3 streaming and Internet radio capabilities •*
- Quick inputs for USB drives and personal music players •*
- Control from any C-Bus touch screen or switch •*
- Scalable from 1 to 24 zones •*
- Flexible wiring topology •*

clipsal.com

Contents

4	4	Installer Features	9	Remote Control
4		Single Zone Systems	10	Flexible Wiring Topology
	6	What's Multi-Room Audio All About?	11	Matrix Switcher
7	7	The Right Look and Feel	12	Amplifiers
		Dual Built-In AM/FM Tuners	15	Programming Software
	8	Quick Input For USB Drives and Personal Music Players	16	C-Bus Ripple Software
8		MP3 Streaming and Internet Radio	17	Accessories
	9	Broadcasting of Announcements	19	Technical Information





Installer Features

The C-Bus Multi-Room Audio (MRA) system is a scalable system that can play music into a simple single location, such as a balcony, or can be installed to distribute different music sources to different rooms in a large installation. Regardless of the installation type, the MRA system uses existing C-Bus switches and touch screens to control the music without the need to put additional plates and screens on the wall.

With different tastes of entertainment within a single home, it makes sense to offer the ability to select from a range of options and choose where and when they may be played. From a simple news broadcast whilst getting ready for work, to party music on the patio, the MRA system offers a full flexible range of sources and control.

Single Zone Systems

Some C-Bus installations, like apartments, may only need a single zone of music, such as on a balcony. C-Bus MRA offers the ability to provide a single stand-alone amplifier with a connection for an MP3 player, with the on/off and volume control provided by any C-Bus switch or touch screen.

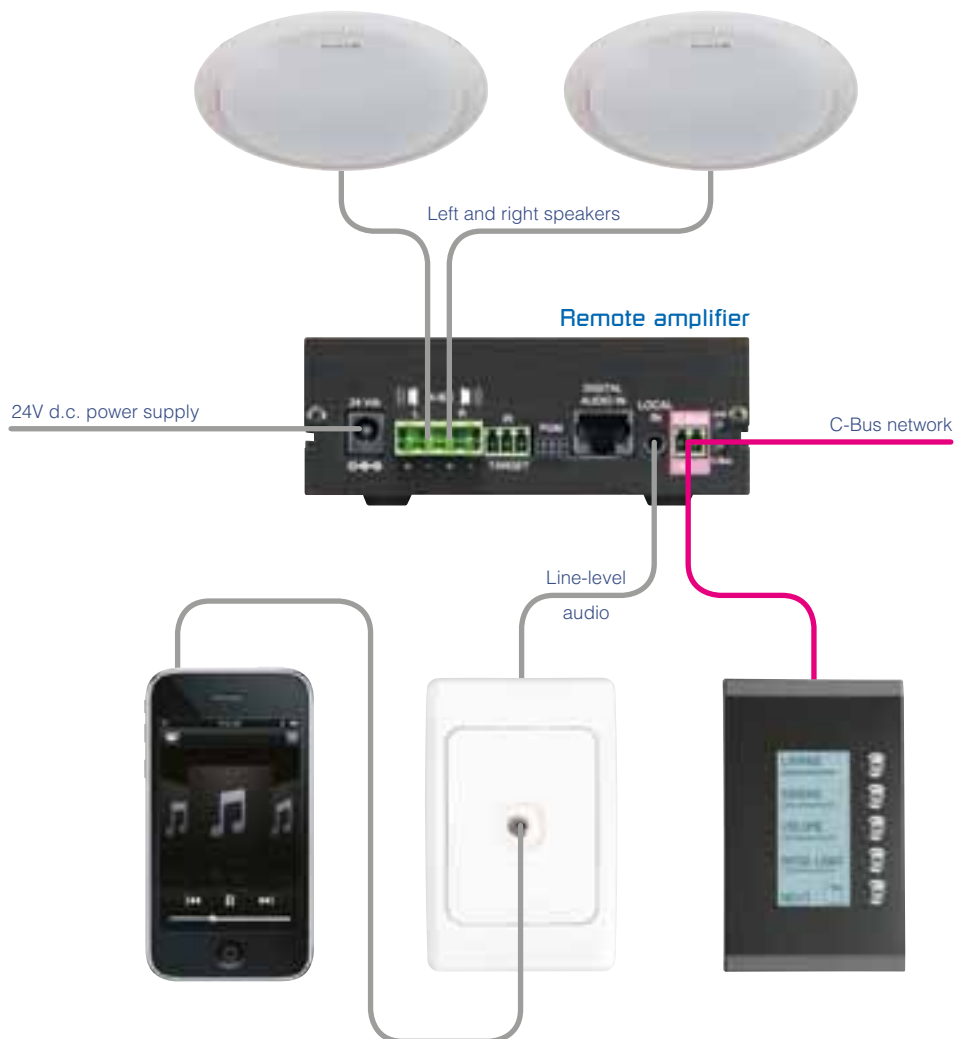

The single zone can be expanded to include a single channel audio distribution unit, which will allow the amplifier to retain the local MP3 player input whilst providing a second input. The audio distribution unit also provides the ability to use infrared reticulation through the amplifier so that the second device can be controlled remotely.

This means that if your additional source can be controlled with a remote control (i.e. DVD player) then you will be able to control it through the infrared reticulation feature included on the audio distribution unit.

Features such as this make the C-Bus Multi-Room Audio system a flexible, scalable audio solution that gives the installer the ability to include more than a single source to their audio zone.

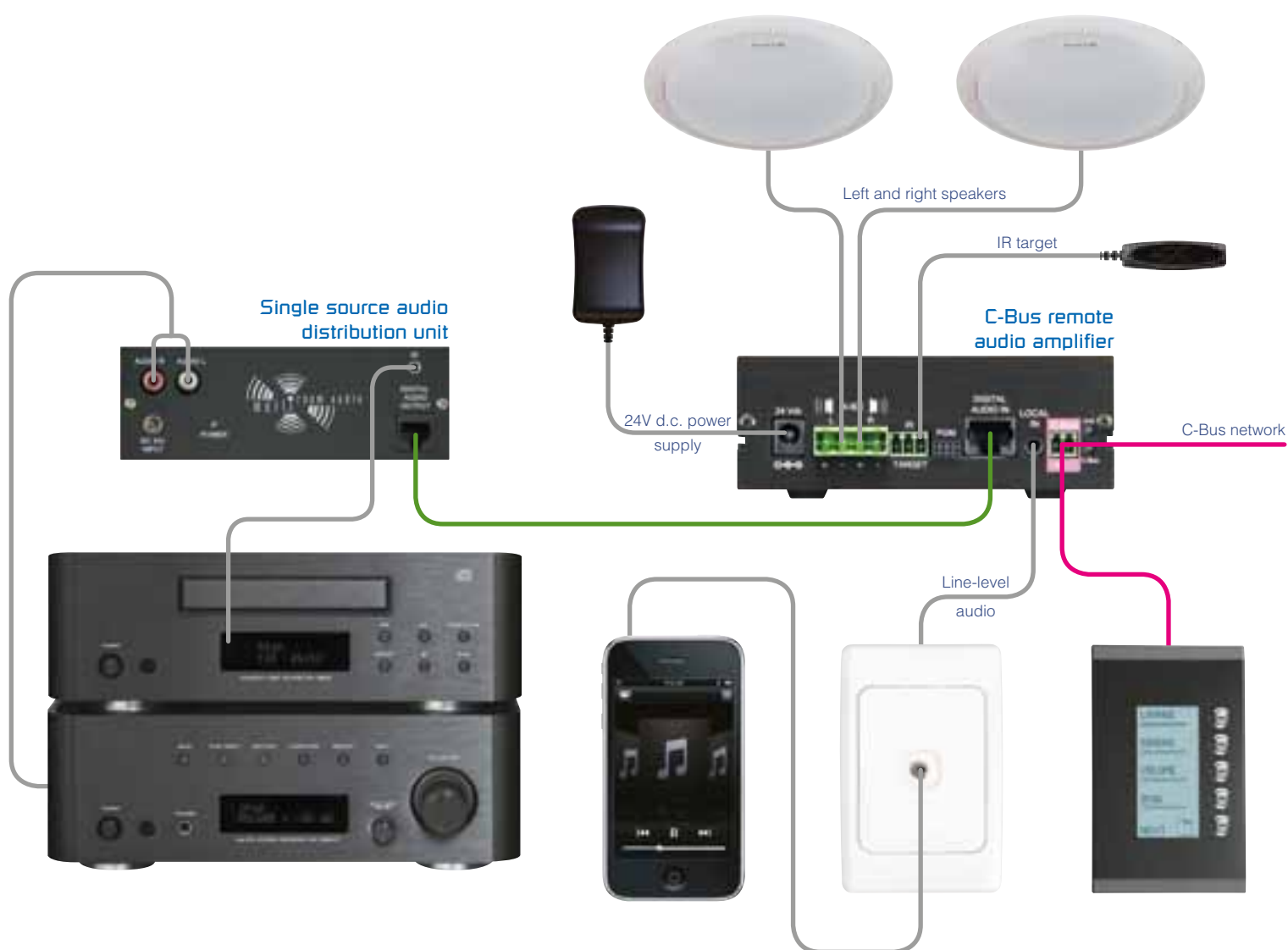

What's Multi-Room Audio All About?

The concept behind multi-room, multi-source music is the ability to listen to different music in different areas at different volumes. The number of areas will vary dramatically depending upon the size of each installation. A system that requires different music sources to be sent to different zones will need a matrix switcher, which co-ordinates what source is routed to each zone. A zone however, may consist of more than one amplifier, like in a bedroom and ensuite where the same music would be played into the two areas but individual volume control is required. This would be configured as a single zone but with two amplifiers, with each of the amplifiers having individual control. Each matrix switcher can support up to eight zones, with the ability to cascade up to three matrix switchers offering as many as 24 zones.



The Right Look and Feel

The highly engineered black anodised aluminium finish of the matrix switcher and low powered remote amplifier make them ideal for installation into home entertainment cabinets or racks. If the amplifiers are to be installed in such a location, four of them can be 'ganged' together so they fit perfectly into a standard width entertainment cupboard or 19" rack. If the number of amplifiers to be installed is not a multiple of four, a blank enclosure can be used to ensure the correct width is maintained.

When a C-Bus system includes touch screens, the MRA can be queried so as to determine the configuration of user changeable information, such as playlists or Internet radio stations. This can then be used to generate dynamic screens that always have the latest information at the users fingertips. These queries can be applied to AM/FM radio stations so that preset stations may be dynamically generated onto touch screen pages.

Dual Built-In AM/FM Tuners

- The C-Bus Multi-Room Audio (MRA) system includes two on-board AM/FM tuners.
- The tuners can independently select from a pool of up to 16 preset radio stations configured during installation. The station band (AM or FM), frequency and ID/name are specified.
- Displaying the current station ID on a C-Bus DLT switch as well as on touch screens makes the system powerful, whilst reducing the number of controllers required in the home.
- Touch screens offer the ability to cycle through the preset stations or select preset stations.
- A library of preset stations can be created and saved so that each project can source from a template of stations.
- Signal strength, station ID and frequency are displayed on the front LCD screen of the matrix switcher.
- When using the C-Bus Media Control application, it's possible to use control commands for:
 - next preset (station)
 - previous preset (station)
 - mute
 - un-mute.



Quick Input for USB Drives and Personal Music Players

Simplicity is the key to any good system. Quite often, there is a requirement to plug a personal MP3 player into the system. The matrix switcher supports inputs for connecting standard devices such as USB drives and personal MP3 players to the system, quickly and easily. The 3.5mm AUX socket, located on the front of the matrix switcher, accommodates the standard mini-jack connection that is found on devices such as personal MP3 players. This enables a user to simply plug in a player, such as an iPod™, and play music without the need for any configuration - great for parties. Likewise, the USB socket on the front of the matrix switcher provides a simple option for playing MP3 files stored on a USB drive. By plugging a USB drive in the socket, the system will recognise and catalogue the files, and play them through the MP3 streaming source. All of the track meta-data (track name, artist, etc.) as well as control, is provided with C-Bus devices such as touch screens.

MP3 Streaming and Internet Radio

Playing digital music with portable music players has been available for some time. The convenience of MP3 files means you can have your entire music library at your fingertips. When you group your individual music tracks into playlists, it's easy to have your choice of music played where and when you want. To come home and disarm the security, have the system recognise this and then play a favourite playlist can be easily accomplished with C-Bus MRA. Using C-Bus Ripple software, custom playlists can be created, whilst having C-Bus devices such as wall switches control them. This can also be extended to Internet radio and podcasts that use the MP3 format.

C-Bus MRA offers the ability to control and monitor many aspects of playing MP3 tracks and radio tuners. Through an in-built hierarchical system it's possible to control and display the contents of a music library including playlists and Internet radio stations on C-Bus touch screens, such as the C-Touch Spectrum. If used with network connected devices, such as the C-Touch Colour Touch screen, album art of the currently playing track can also be displayed.

Having the ability to send track information over C-Bus gives the user the ability to view and control their library from all C-Bus touch screens. A screen can show the current track, the next track, the next two pending tracks as well as the previous two tracks played. The same can be applied to Internet radio stations and even playlists. It's also possible to go directly to a playlist without cycling through a list. This also applies to radio tuners, where it's possible to either cycle through the radio station presets or go to the channel instantly. Radio station cycling can also be performed on DLT switches, with the current radio station ID being displayed on the DLT screen.



Broadcasting of Announcements

Broadcasting of announcements to selected zones adds to the rich features of the system. Through low and high priority line-level inputs on the matrix switcher, the system can interrupt normal listening to broadcast these announcements. This can be further extended to include small sound files stored in the matrix switcher, which can be used for functions such as a doorbell, driveway alert or even a 'you have mail' announcement.

Remote Control

Infrared reticulation offers the ability to have an infrared target placed in the field near an amplifier, so that signals from a remote control, aimed at the target, are routed back to the matrix switcher and may be blasted to control AV equipment. Control of devices, such as a cable TV set-top box, from a remote location (where a desktop amplifier is installed near a TV) can really enhance a system. Infrared blasting of learned codes out of the matrix switcher's IR emitter ports, when triggered by C-Bus commands, can also control AV devices. This may be a next track command to a CD player. With two individually addressable IR ports on the matrix switcher, the ability to control two pieces of equipment that use the same IR codes is possible.



Flexible Wiring Topology

A flexible wiring topology offers the installer the ability to place amplifiers in either a central location (next to the main entertainment equipment) or in a remote location (in the field near the speakers) or even a combination of both. Each amplifier only requires the digital feed cable from the matrix switcher to provide power for the amplifier as well as the audio signal and the reticulated infrared signal. Amplifiers also require a C-Bus

connection for control. The digital cable can run up to 45 metres from the matrix switcher to an amplifier and can be cascaded to additional amplifiers if there is more than one per zone. The ability to connect local power supplies to amplifiers is also possible if a higher volume output is required.

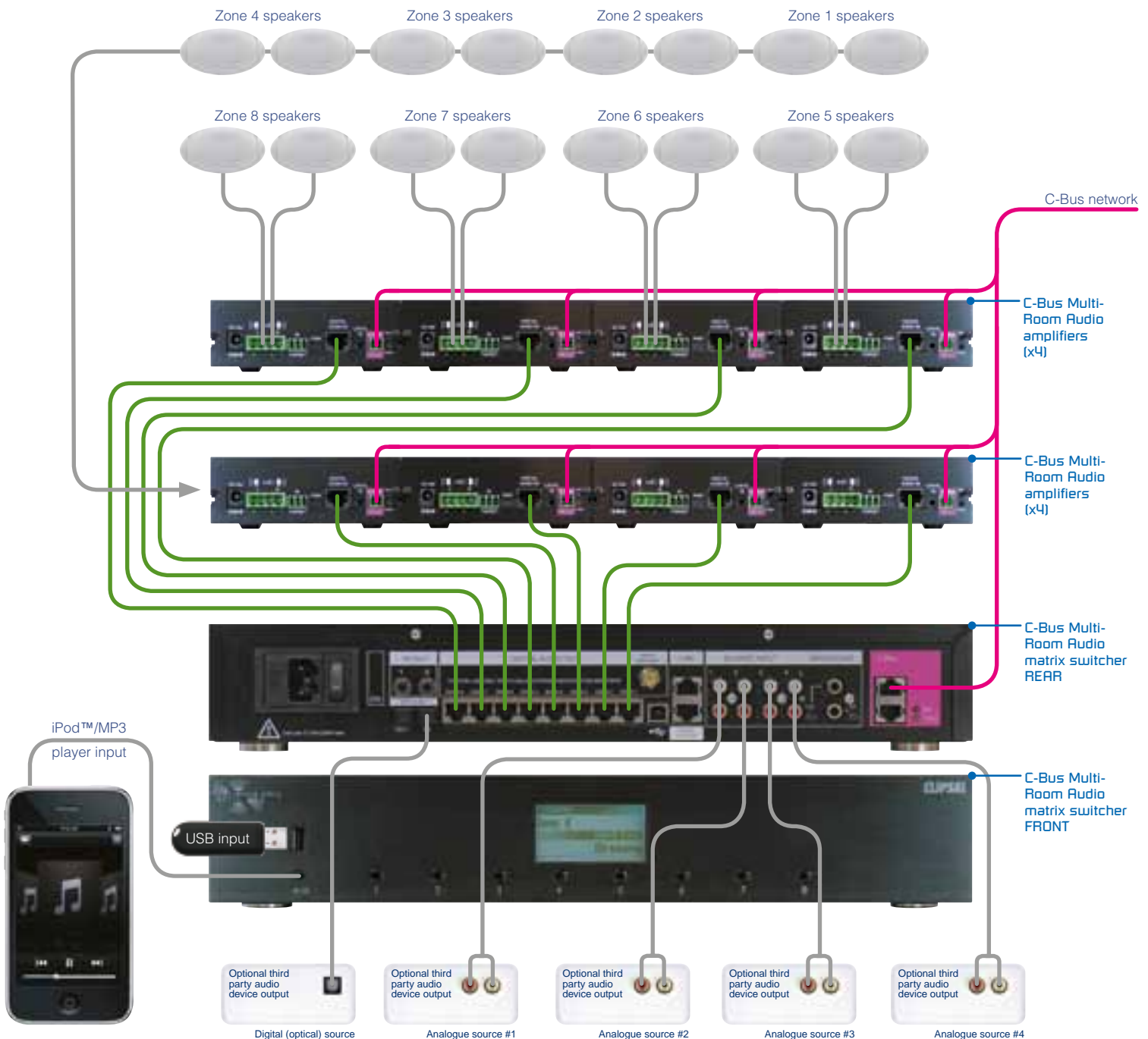

Matrix Switcher

The heart of the multi-room, multi-source audio system is the matrix switcher. Produced in a black anodised aluminium finish, the matrix switcher is designed to fit in with audio visual equipment installed into entertainment cabinets or rack-mount installations. Two models of the matrix switcher are available; with and without MP3 streaming capabilities. Even if the non-streaming model is chosen, it can be upgraded at a later date to include streaming. The LCD screen with backlight control (on the front of the matrix switcher) can display the currently selected radio stations from the in-built radio tuners, along with their signal strength. The front fascia also includes a 3.5mm socket for the connection of a personal music player as well as a user USB socket to accommodate MP3 files streaming from a USB drive.

The rear of the matrix switcher provides all of the connections for audio system equipment so their signals can be fed directly into the MRA system. Most systems provide a line-level signal that can be connected to one of the four pairs of RCA sockets, whilst there is an optical input for devices such as a DVD player. The rear panel also includes a USB connection for installer configuration of the matrix switcher using the MARPA

programming software. If control of the third party connected audio hardware is required, there are two infrared emitter ports that can be used to blast learnt commands to the devices or as part of the pass-through infrared engine, which forms part of the system.

The local area network (LAN) connection port enables the matrix switcher to be connected to the installation's computer network. This is required if the system is to stream MP3 music from a computer on the network running the C-Bus Ripple streaming software. The music stream is sent from C-Bus Ripple to the matrix switcher, along with information about the song such as track name. The matrix switcher then feeds the information about the song to C-Bus so that it can be displayed onto devices such as touch screens. C-Bus also provides the ability to control the MP3 stream directly from C-Bus devices by relaying commands back to C-Bus Ripple. Commands such as play, pause, next track, etc, form part of these control commands. When a matrix switcher determines that no zone is listening to the Internet radio or MP3 stream, C-Bus Ripple will pause the feed to ensure valuable Internet download is not being consumed.

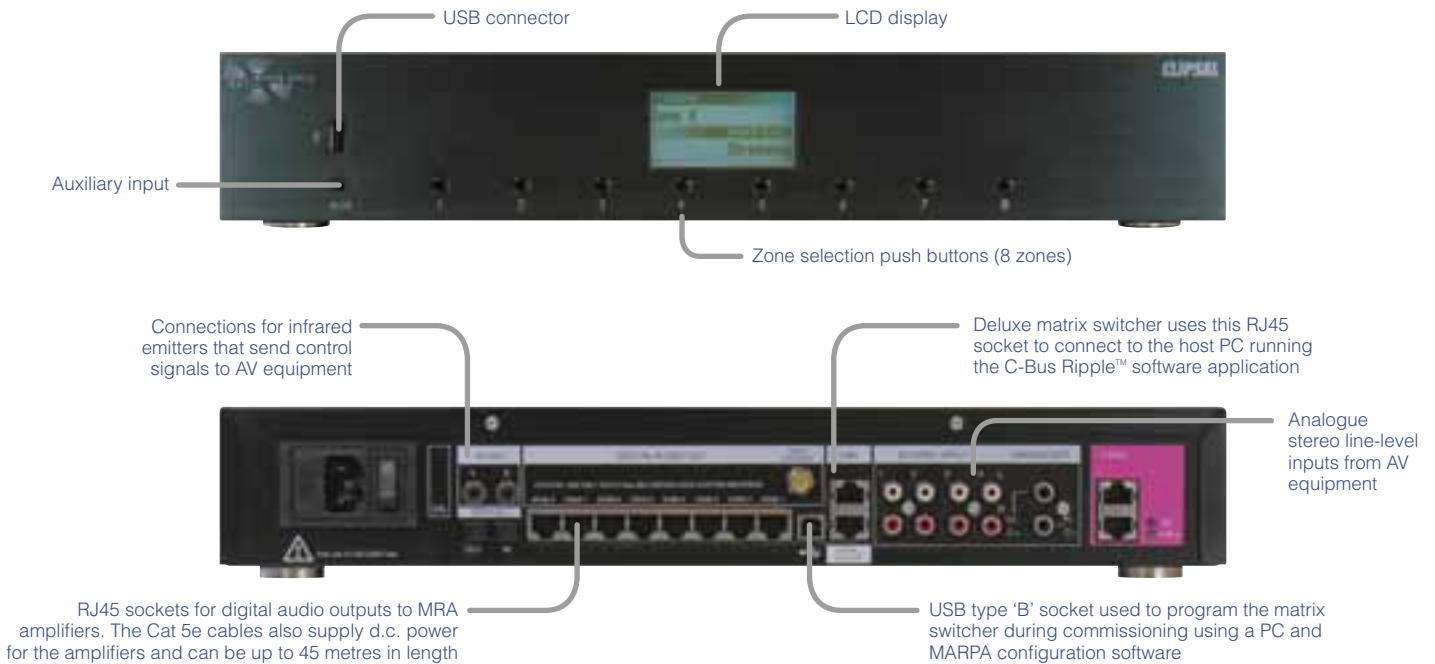

Amplifiers

The MRA system offers a range of amplifiers to suit most applications. Both low and high power remote amplifiers are designed to be installed into a range of environments. Remote amplifiers have a high temperature rating so they can be installed into a roof space with or without the optional mounting bracket. If an external power supply is required to be installed into the harsh environment, the 5600P24H3750A power supply must be used.



Amplifier installed in roof space

If an amplifier is being installed into a location that is not so harsh, such as a walk-in robe, the amplifier can be placed on a shelf. If an external power supply is required in this scenario, the 5600P24/3750AU power supply can be installed for the high power unit, whilst the 5600P24/1250 power supply can be used for the low powered unit. If the low powered amplifier is to be installed alongside the entertainment equipment, the unit can be connected together with other low powered amplifiers.



Amplifier installed in walk-in robe

When four amplifiers are connected together in this fashion, they fit neatly into a 19" rack. If the number of connected amplifiers is less than four, blank enclosures are available to ensure the unit will space out to the full width.





Like the matrix switcher, the low powered amplifier has a black anodised aluminium finish so it looks right at home with other entertainment equipment. All of the connections to the amplifier are of a plug-in nature, so if the amplifier needs to be removed for any reason (say security during the commissioning of a system before handover to the customer), this is a painless exercise. All amplifiers support infrared remote control reticulation so that when used with either the matrix switcher or the audio distribution unit, Infrared (IR) targets can take IR signals that can be reticulated back to controlled equipment.

All amplifier models include a local input port that is line-level stereo, whilst both of the high powered models include an optical input too. This local input offers the ability to connect a local source, such as an iPod™, so the zone can have its own local, private music. This local input is utilised when a C-Bus installation only requires a single zone of music with no matrix switcher. The amplifier is controlled through the C-Bus system, from devices such as wall switches and touch screens. Should the simple installation require a little more than just a single local connection, the audio distribution unit (ADU) can be used to send a second audio signal from a device such as a cable TV decoder. When the ADU is used in this fashion, an optional IR target can be provided to enable control of the TV decoder, as the ADU includes an infrared emitter port, where an emitter can be plugged in.

Amplifiers can be cascaded in a master/slave configuration so they can be expanded to serve multiple areas that require the same music source. The high powered amplifiers have a loop-in/loop-out provision for cascading, whilst the low powered model requires the use of the optional tee unit (Cat. No. 5600TEE). Typically, an outdoor patio and pool area with this master/slave configuration of amplifiers, but sharing the same source, could accommodate this style of installation. By cascading the amplifiers, an installation can have more areas on a single zone, altogether expanding the system capability.

The 25 Watt desktop amplifier provides a solution for environments where an amplifier needs local control as well as control through a C-Bus system. Desktop amplifiers also include infrared remote capabilities to control the amplifier directly and a local headphone socket for personal use. All other features found on the high powered remote amplifier (excluding the high temperature rating) can be found on the desktop amplifier.



Programming Software

The MRA system is a C-Bus controlled system and therefore needs to be programmed using the C-Bus Toolkit software. If a stand-alone single zone is installed, there is no need to use the MARPA software that is required for installing more extensive multi-room, multi-source systems. Configuration of volume, bass and treble control, along with the source control, is provided using Toolkit. Additional options, including the ability to reset muted zones on power-up and which zones should process priority broadcasts such as doorbells, can be configured here.

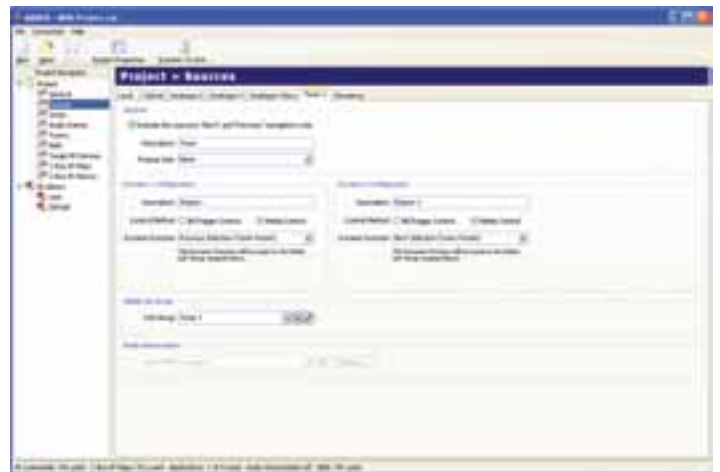

required.

The PICED programming software is used to configure touch screens and logic based devices. The media application used with the MRA system offers the installer the ability to create some elaborate control screens that can display tailored information for users. All of the media control application can be used in logic based programming to create even greater functionality. Typically, a logic scenario might be used to switch the playing source to a radio station if the MP3 queue finishes playing.

When a C-Bus MRA system includes a matrix switcher, the system project is created using the MARPA programming software. Once the project is created, it can be transferred to the matrix switcher. MARPA configures all aspects of the matrix switcher, including the specification of the powerful infrared engine and the codes it will blast out to control devices.

The MARPA software also includes the C-Bus IP configuration utility, used to set up the network aspects of the matrix switcher. The order and type of sources supported by the matrix switcher can be determined by the installer during configuration using MARPA. This includes the loading of radio station presets, audio scenes, doorbells and the information that will be broadcast to Dynamic Labelling Technology (DLT) switches connected to the system. Tuner presets can also be loaded from a database to speed up installation using MARPA. If a stand-alone system with no matrix switcher is required, then the MARPA software is not



C-Bus Ripple Software

The C-Bus Ripple streaming software has been designed to operate in conjunction with the MRA system. C-Bus Ripple provides the user with a simple method of organising their music collection using standard conventions found with most music playing software such as playlists. The software offers the ability to build and save playlists as well as stream Internet radio directly to the MRA system. The powerful search function enables the user to locate tracks, artist or even partial searches for easily adding to playlists or the music queue. Smart features like highlighting duplicate tracks in playlists and queues as well as tracks that have already been included speeds up the user experience. The user can compile custom compilations by highlighting multiple tracks, complete albums or even genres and drag them to their playlist. C-Bus Ripple provides a music queue which can even include podcasts and Internet radio stations. By placing an Internet radio station as the last item in the queue, the completion of tracks playing will see the Internet radio station coming online to ensure continuity of music. C-Bus Ripple can also play through the host computer's sound card as long as Windows Media Player is installed and it supports the playing of MP3 files, offering a second independent output. C-Bus Ripple can support up to four independent matrix switchers as well as the host PC; all streaming different content at the same time.

C-Bus Ripple offers three panes for viewing the music library, the current music queue and the currently playing track. Music libraries can exist on one or many network drives. C-Bus Ripple offers the ability to monitor changes to the library structure and in doing so, can detect any changes to music being added or removed from the drives. This detection can also be manually activated to include music that may have just been added.

C-Bus Ripple works with the MRA system to provide information about the currently playing track to C-Bus devices. This includes album art for network enabled devices such as the C-Touch Colour Touch screen. Transport control from C-Bus devices operate in the same way as on the player in C-Bus Ripple, including:

- Play
- Stop
- Pause
- Next (track)
- Previous (track)
- Fast Fwd (x 4 speed)
- Fast Rwd (x 4 speed)
- Repeat all tracks
- Repeat track
- Shuffle.



C-Bus Ripple streaming software



C-Bus Ripple streaming software



Accessories

Speakers

Having great speakers can complete the whole MRA experience. Whether requiring the discreet downlight sized Holographix speakers or the all-weather Tropix, the MRA system is completed by the range of quality Krix speakers on offer. These include:

Cat No 5600K01-WE	Holographix Speakers
Cat No 5600K02-WE	Hemispherix Speaker
Cat No 5600K03-WE	Atmospherix Speaker
Cat No 5600K04-WE	Ecliptix Speaker
Cat No 5600K06-WE	Aquatix Speakers
Cat No 5600K06-BK	Aquatix Speakers
Cat No 5600K07-WE	Tropix Speakers
Cat No 5600K07-BK	Tropix Speakers



Audio Distribution Unit

The audio distribution unit (ADU) offers the ability to expand a stand-alone system to include a second source with infrared reticulation capabilities. When used with a stand-alone amplifier, the unit does not require a separate power supply. The ADU takes a line-level signal and converts it to the MRA digital signal that the amplifiers can decode. The ADU can be located up to 45 metres from the amplifier it is providing the signal to.



Blank Unit

When four low powered amplifiers are ganged together, a perfect 19" rack mount size is achieved. If however, less than four amplifiers are being installed and the full rack width is required, the optional blank unit can be installed to give that 'complete look'.

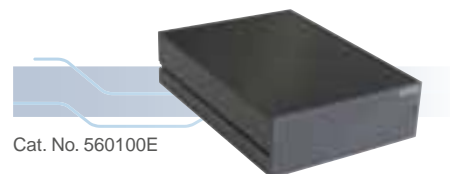

Bluetooth Receiver

A great option to connect personal music players that support Bluetooth is through the optional Bluetooth receiver. The receiver includes an adjustable line-level output that can be connected to the matrix switcher or act as a local input into an amplifier.



Power Supplies

Although the matrix switcher provides power to amplifiers, sometimes there is a requirement for additional power supplies, particularly when there are multiple amplifiers installed onto a single zone. There are a number of power supply options available for both the low powered and the higher powered amplifiers. If an amplifier is installed in a stand-alone configuration (ie without a matrix switcher), it will require a power supply. If the power supply is to be installed into a high temperature location (in a roof space), the high temperature power supply (Cat. No. 5600P24H3750A) will need to be used. This is suitable for both the low powered and the standard remote amplifiers. If the low powered amplifier is to be installed into a non-harsh environment (say onto the shelf of a walk-in robe), the standard power supply (Cat. No. 5600P24/1250) should be used. For either the desktop or standard remote amp installed into a non-harsh environment, the power supply (Cat. No. 5600P24/3750AU) should be used.



Cat. No. 5600P24/1250



Cat. No. 5600P24/3750AU

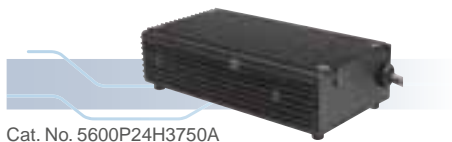

Cat. No. 5600P24H3750A

Amplifier Mounting Bracket

If either of the remote amplifiers need to be fixed to a wall or a beam, there is a mounting bracket available for both types. For the standard remote amplifier use the mounting bracket (Cat. No. 560125MB) whilst for the low power remote amplifier, use the mounting bracket (Cat. No. 560110MB).

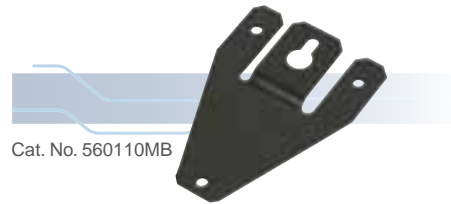

Cat. No. 560110MB

Streaming Card Upgrade

The standard matrix switcher does not have the internal card required for streaming music from the C-Bus Ripple software. It does however have all of the provisions for accepting the streaming card (Cat. No. 5600EC) as an upgrade, which can be purchased and installed at a later date.

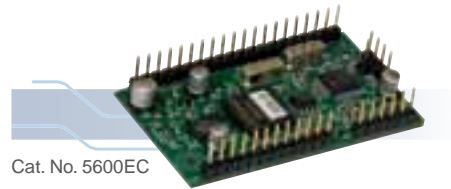

Cat. No. 5600EC

Technical Information

Matrix Switcher

Parameter	Description
Supply Voltage	120 to 240V a.c.
Mains Frequency Range	47 to 53Hz and 57 to 63Hz
a.c. Input Impedance	47k Ω
Power Consumption	220W (maximum)
C-Bus Supply Voltage	15 to 36V d.c.
C-Bus Sink Current	22mA. The matrix switcher does not supply current to the C-Bus network
Network Clock And Burden	Software selectable
Source Input Signal Level	2.8V p-p maximum (47k Ω)
Audio Inputs	4 x analogue line-level inputs 1 x digital optical input 2 x internal AM/FM tuners 1 x auxiliary input socket (headphone level) 1 x MP3 streaming client 2 x annunciation inputs (1 x high priority, 1 x low priority)
MP3 Streaming	320Kbps (max)
Infrared Reticulation	36-56khz
A/D Conversion	16 bit PCM
Operating Temperature	10 to 40 °C (50 to 104 °F)
Operating Humidity	10 to 90% RH (non condensing)
Weight	6kg (13.2lb)
Dimensions (in mm)	436W x 288D x 80H
Catalogue Numbers	Standard matrix switcher: 560884/2 Deluxe matrix switcher(with streaming): 560884/2E

Amplifiers

Parameter	Description
Supply Voltage	25W amplifiers 24V d.c. @ 3.75A when using external power supply. 10W amplifier - 24V d.c. 1.25A when using external power supply, 27V d.c. when powered by the matrix switcher (via digital audio connection)
Power Consumption	Desktop and remote amp: 90W (maximum) Low power remote amp: 30W (maximum)
Maximum Power Output	Desktop and remote amp: 28W RMS into 4 Ω (0.514% THD) Low power remote amp: 10W RMS into 6 Ω (0.514% THD)
Frequency Response	40Hz to 20kHz (+/- 1 dB)
Total Harmonic Distortion (1kHz, 20W RMS into 4 Ω)	0.36% (using analogue input)
Signal to Noise Ratio	>67db (peak, unweighted)
Analogue Input Signal Level (local input)	2.8V p-p maximum (47k Ω)
D/A Conversion	16 bit PCM
Network Clock and Burden	Software selectable
C-Bus Supply Voltage	15 to 36V d.c.
C-Bus Sink Current	22mA
Operating Temperature	Desktop amp.: 10 to 40 °C (50 to 104 °F) Remote amp.: 0 to 70 °C (32 to 158 °F) Low power remote amp.: 0 to 70 °C (32 to 158 °F)
Operating Humidity	10 to 90% RH (non condensing)
Catalogue Numbers	Desktop amplifier: 560125D/2 Remote amplifier: 560125R/2 Low power remote amplifier: 560110R

Clipsal Australia Pty Ltd

A member of Schneider Electric

Head Office

33-37 Port Wakefield Road,
Gepps Cross, South Australia 5094

PO Box 132, Enfield Plaza
South Australia 5085

Website clipsal.com/cis
Contact us cis@clipsal.com.au

CIS Technical Support Hotline:

Australia	1300 722 247
New Zealand	0800 888 219
Northern Asia (Hong Kong)	+852 2484 4157
South Africa	011 314 5200
Southern Asia	+603 7665 3555 x236 or 242
United Kingdom	+44 870 608 8 608
Technical Support Email	cis_support@clipsal.com.au

National Customer Care Enquiries:

1300 2025 25

National Customer Care Facsimile:

1300 2025 56

International Enquiries
International Sales and Marketing
Email export@clipsal.com.au

New Zealand
Schneider Electric (NZ) Ltd
Telephone +64 9 829 0490

You can find this brochure and many
others online in PDF format at:
clipsal.com

Follow the links off the home page or access
the following page directly: **[clipsal.com/
brochures](http://clipsal.com/brochures)**

clipsal.com/cis

Clipsal Australia Pty Ltd reserves the right to change specifications, modify designs and discontinue items without incurring obligation and whilst every effort is made to ensure that descriptions, specifications and other information in this catalogue are correct, no warranty is given in respect thereof and the company shall not be liable for any error therein.

© Clipsal Australia Pty Ltd

This material is copyright under Australian and international laws. Except as permitted under the relevant law, no part of this work may be reproduced by any process without prior written permission of and acknowledgement to Clipsal Australia Pty Ltd. The identified trademarks and copyrights are the property of Clipsal Australia Pty Ltd unless otherwise noted.

 printed on recycled paper