

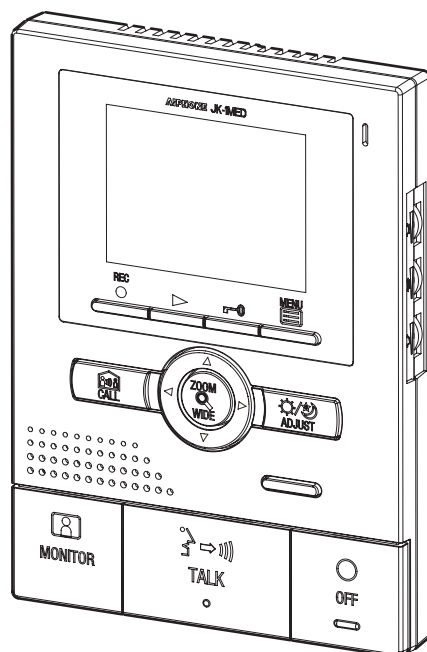

# JK-1MED

**HANDS FREE COLOR VIDEO INTERCOM MASTER MONITOR STATION**  
**INTERPHONE VIDEO COULEUR MAINS LIBRES MONITEUR MAÎTRE**  
**HANDENVRIJE KLEURENVIDEOFONIE MONITOR-HOOFDPOST**



## JK-1MED

Master monitor station  
Moniteur maître  
Monitor-hoofdpost

INSTALLATION & OPERATION MANUAL  
MANUEL D'INSTALLATION ET D'UTILISATION  
INSTALLATIE- EN GEBRUIKSHANDLEIDING

# PRECAUTIONS

- General Prohibitions    
 Prohibition to Dismantle the Unit    
 Prohibition on Subjecting the Unit to Water    
 General Precautions

## WARNING

**(Negligence could result in death or serious injury.)**

1. High voltage is present internally. Do not open the case. Electric shock could result.
2. Do not dismantle or alter the unit. Fire or electric shock could result.
3. Do not connect any non-specified power source to the +, - terminals. Also, do not install two power supplies in parallel to a single input. Fire or damage to the unit could result.
4. Keep the unit away from water or any other liquid. Fire or electric shock could result.
5. Do not put any metal or flammable material into the unit through the openings. Fire or electric shock could result.
6. Do not use power supply with a voltage other than specified. Fire or electric shock could result.
7. Do not connect any terminal on the unit to an AC power line. Fire or electric shock could result.

## CAUTION

**(Negligence could result in injury to people or damage to property.)**

1. Do not install or make any wire terminations while power supply is plugged in. It can cause electrical shock or damage to the unit.
2. Before turning on power, make sure wires are not crossed or shorted. If not, fire or electric shock could result.
3. When mounting the unit on a wall, install the unit in a convenient location, but not where it could be jarred or bumped. Injury could result.
4. For power supply, use Aiphone power supply model or model specified for use with system. If non-specified product is used, fire or malfunction could result.
5. Do not install the unit in any of the following locations. Fire, electric shock, or unit trouble could result.
  - \* Places under direct sunlight or places near heating equipment that varies in temperature.
  - \* Places subject to dust, oil, chemicals, etc.
  - \* Places subject to moisture and humidity extremes, such as bathrooms, cellars, greenhouses, etc.
  - \* Places where the temperature is quite low, such as inside a refrigerated area or in front of an air conditioner.
  - \* Places subject to steam or smoke (near heating or cooking surfaces).
  - \* Where noise generating devices such as dimmer switches or inverter electrical appliances are close by.
  - \* Do not install the unit in locations subject to frequent vibration or impact.
6. Do not put anything on the unit or cover the unit with cloth, etc. Fire or unit trouble could result.
7. Do not press on the LCD or subject it to a high impact. The LCD glass could be punctured and result in an injury.
8. If the LCD is punctured, do not allow skin contact with the liquid crystal inside. Inflammation could result.
  - \* If liquid crystal is ingested, immediately gargle with water and seek medical attention.
  - \* If contact with the eyes or skin occurs, clean with pure water for at least 15 minutes and seek medical attention.

## General Precautions

1. Keep the unit more than 1 m away from radio or TV set.
2. This unit is for indoor use only. Do not use outdoors.
3. In areas where broadcasting station antennas are close by, the intercom system may be affected by radio frequency interference.
4. As to other manufacturer's devices (such as sensor, detectors, door releases) used with this system, comply with the Specifications and Warranty conditions that the manufacturers or vendors present.
5. Keep the intercom wires at least 30 cm (12") away from AC 100-240 V lines. Noise and malfunction could result.
6. If the unit is down or does not operate properly, unplug the power supply or turn off the JK-1MED and JK-1HD (JK-1SD) POWER switches.
7. The unit is for wall-mount use only. For desktop applications, use desk stand.
8. When wall-mounted, the top of the unit may darken. This does not indicate a malfunction.
9. The unit case may become warm with use, but this is not a unit malfunction.
10. If a cellular phone is used close by, the unit may malfunction.
11. The LCD panel is manufactured with very high precision techniques. Small portions of the panel may fail to light up or some portions may be constantly lit, but this does not indicate a unit malfunction. Please be aware of this in advance.
12. Refrain from using the color monitor station in sunlight areas.
13. At night, due to reduced lighting on the object, the monitor sees more noise and the face becomes more difficult to see, but this is not malfunction.
14. Talk within 50 cm (20") or less from the unit. If you stand too far away, it may be difficult for the other person to hear the communication.
15. If there are loud noises around the unit (such as music playing or children crying), the sound may break up and be difficult to hear.
16. During communication, if you speak before the other person has finished talking, your voice may not come through clearly. Communication will proceed smoothly if you wait until the other person has finished before speaking.
17. At a gate or porch illuminated by a fluorescent lamp, the picture may vary, but this is not a malfunction.
18. When outside temperature lowers sharply after rainfall, etc., the inside of the camera may fog up slightly, causing a blurry picture, but this is not a malfunction. Normal operation will be restored when moisture evaporates.
19. Due to the environmental sound around the unit, it may hinder smooth communication, but this is not a malfunction.
20. The outline of video images displayed by video door station may differ from that of the actual person(s) or background, but this is not a malfunction.
21. If the screen of a video door station freezes during wintertime, the picture may become difficult to see or the CALL button may not move, but this is not a malfunction.
22. Aiphone assumes no responsibility for corruption of saved information (such as changes to or deletion of saved information). Please be aware of this in advance.
23. This unit is not compatible with JA, JF, KB, and KC series units.
24. Warm-color lighting shining on the door station may change the tint of the picture on the monitor.

# 1 PACKAGE CONTENTS

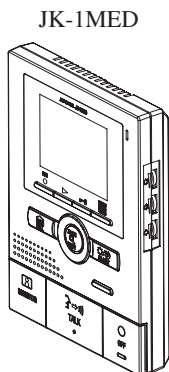

Mounting screws x 2



Wood mounting screws x 2



Option connector



Installation & Operation manual

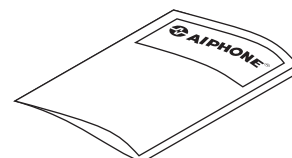

# 2 INSTALLATION

## 2-1 Mounting locations

- 1 Install the master monitor station in a place where the screen is not exposed to direct sunlight.
- 2 The master monitor station has switches on both sides. Allow at least 5 cm (2") of open space on either side.
- 3 Allow at least 15 cm (6") of vertical open space from the center of the mounting bracket in order to mount the master monitor station.

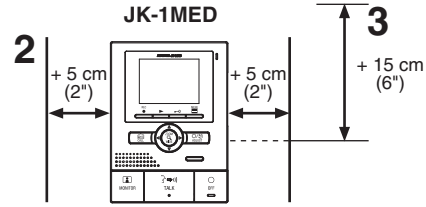
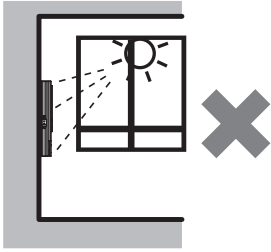

## 2-2 Wiring method, wiring distance

Wire the units from station-to-station (daisy-chained).

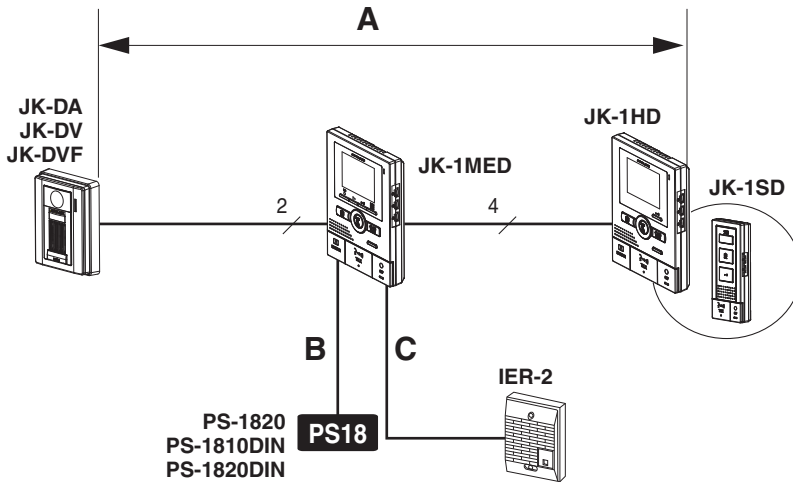

	Ø 0,65 mm	22 AWG	Ø 1,0 mm	18 AWG
A	50 m	165'	100 m	330'
B	5 m	16'	10 m	33'
C	75 m	245'	150 m	490'

## 2-3 Cable

- 1 Use PVC jacket with PE (polyethylene) insulated cable
- 2 Never use individual conductors, twisted pair cable or coaxial cable.
- 3 When using a cable with unused conductors, terminate both ends of the unused pair(s) with a 120 Ω resistor.



- 2 Never use individual conductors, twisted pair cable or coaxial cable.

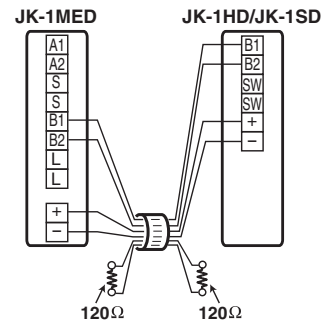
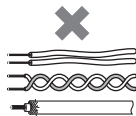

# 3 WIRING

Insert wires securely into each terminal as shown.

English

Français

Nederlands

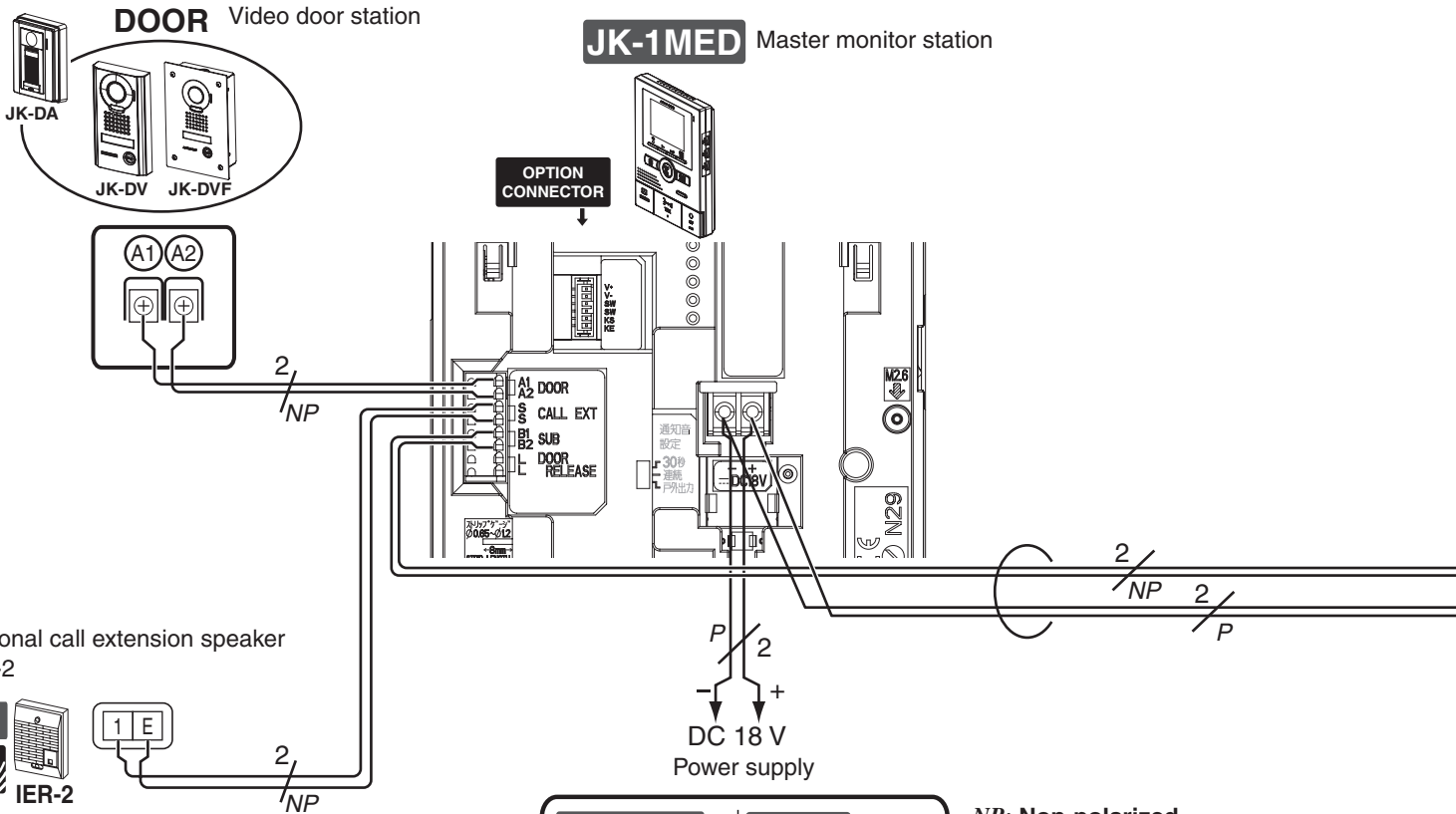

Optional call extension speaker IER-2



Presence of sound from IER-2

Item	Sound
Chime tone from door station (8-1)	○
Alarm sound during external sensor input (8-15)	○
Audio during instant voice call (8-1)	-
Chime tone during room-to-room communication (8-4)	-

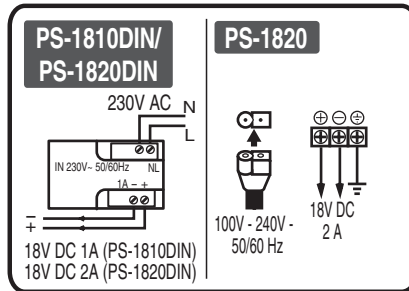

NP: Non-polarized  
P: Polarized

## Door release

An EL-12S (AC 12 V 0.125 A, DC 12 V 0.2 A) or equivalent part and a separate AC transformer are required.

Run separate cables for audio/video and door release.

Door release contact: AC/DC 24 V, 0.5 A (Minimum Contact : 100 mV DC, 0.1 mA)

(N/O dry closure contact L, L).

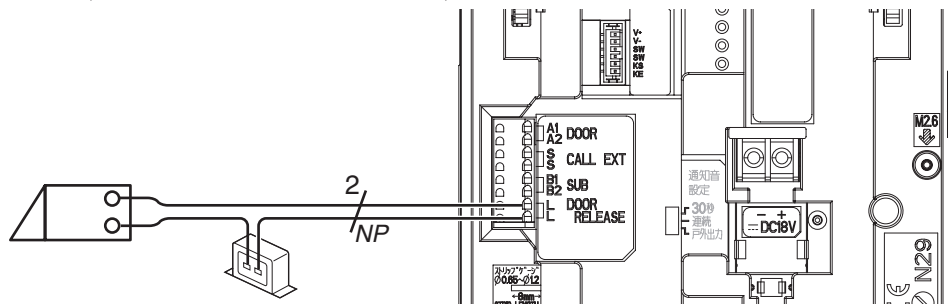
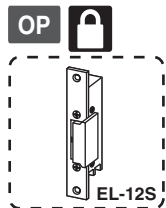

AC transformer

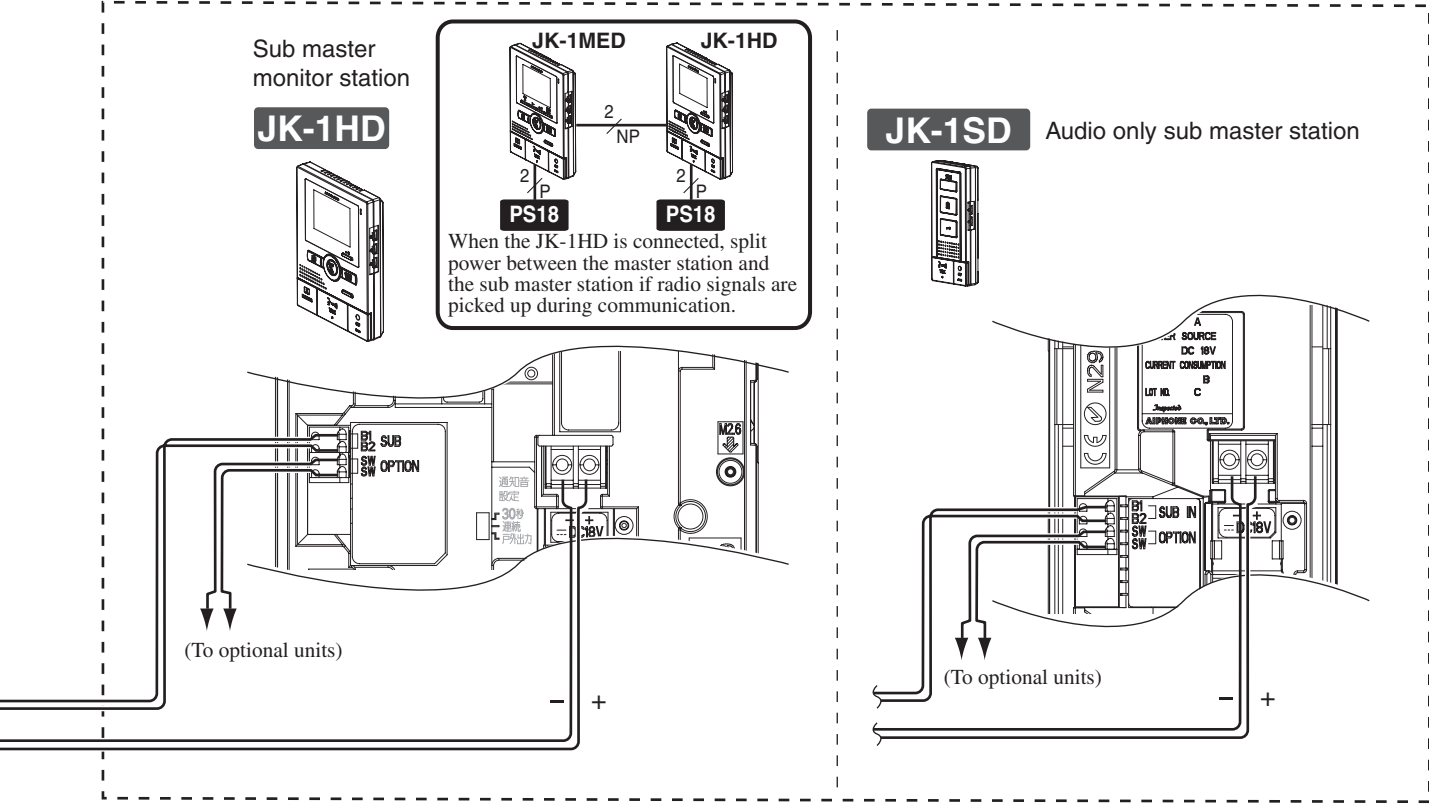

Option connector: Control external devices connected with the option connector.

**OPTION CONNECTOR**

(BR) V+ [1] BR: Brown  
(RD) V- [1] RD: Red  
(OR) SW [2] OR: Orange  
(YE) SW [2] YE: Yellow  
(GR) KS [3] GR: Green  
(BL) KE [3] BL: Blue

⚠ To prevent shorts, be sure to cut unused lead wires at the bottom and insulate the ends.

[1] Video signal output: Video can be output to DVR, etc. (NTSC, 1 Vp-p/75 Ω ) Wiring distance: 3 m  
NOTES: When a video signal is output, the monitor station may produce a buzzing sound depending on the installation environment.  
A video signal is only output during calling from a door station to the JK-1MED/during communication between a door station and the JK-1MED/during monitoring from the JK-1MED (screen playing recorded pictures is not output).

[2] Options output (AC/DC 24 V, 1.6 A N/O dry closure contact)  
(Minimum Contact : 100 mV DC, 0.1 mA)

[3] External sensor input settings are required.

External sensor input specifications

Input method	N/O dry closure contact External sensor input (start signal only detection method)
Detection confirmation time	100 mS or more
Contact resistance	During N/O dry closure: Less than 700 Ω During N/C dry closure: At least 3 k Ω
Terminal short current	Less than 10 mA
Voltage between terminals	Less than DC 20 V (when open between terminals)

Optional long distance adaptor JKW-BA

Use the long distance adaptor JKW-BA within the distance ranges shown in the table when the wiring distance between the door station and the furthest inside unit is longer than the distance in 2-2 on p. 3.

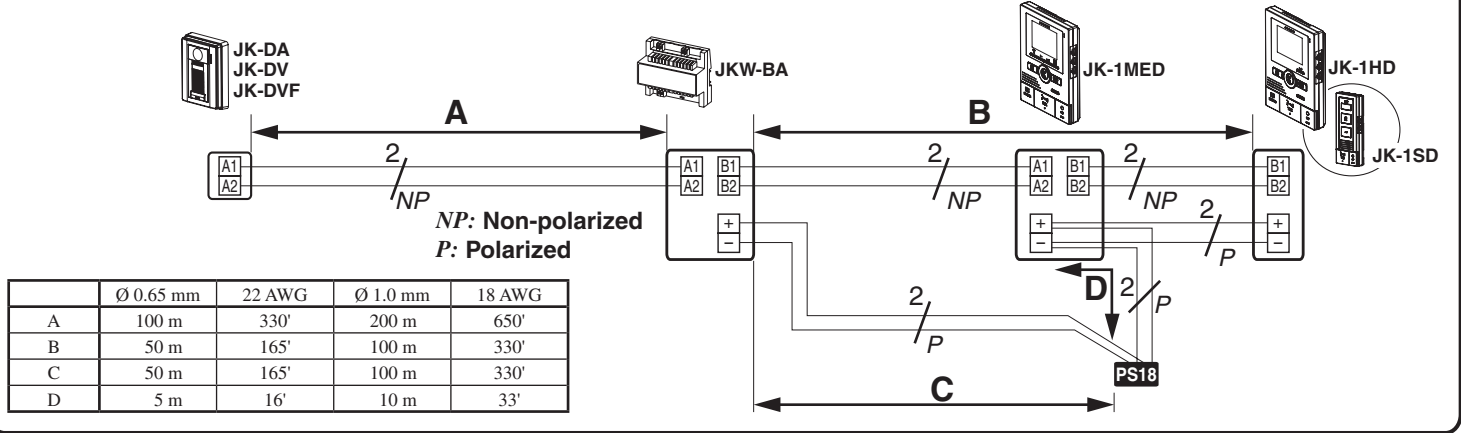

# 4 MOUNTING

## Back wiring

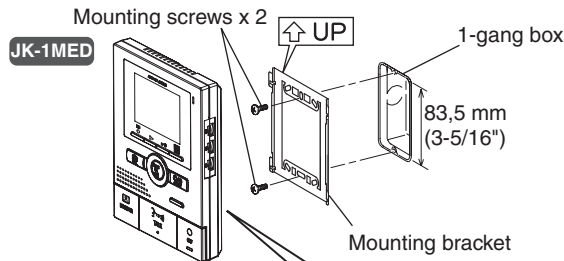

1. Press RELEASE button (to insert or remove the wire).
2. Insert the cable into the terminal.

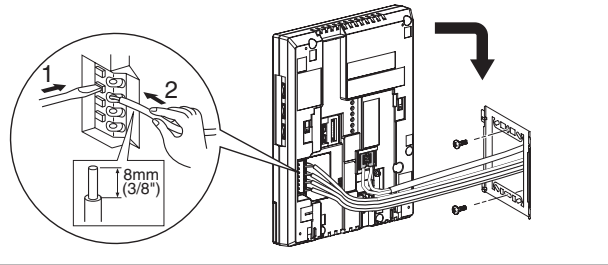

## Surface wiring

\* When a 1-gang box is not mounted, the cable can be routed as surface wiring to the top or bottom of the unit. Cut a cable inlet on the upper part of the unit to allow passage of the wiring into the unit.

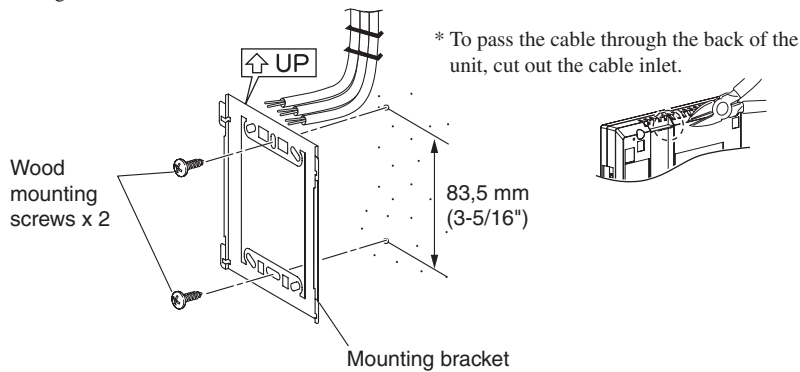

## PS-1820

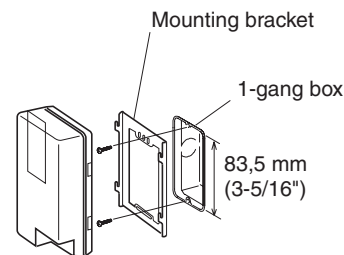

## PS-1810DIN/ PS-1820DIN

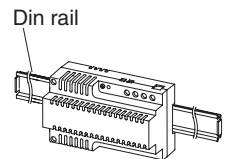

# 5 NAMES

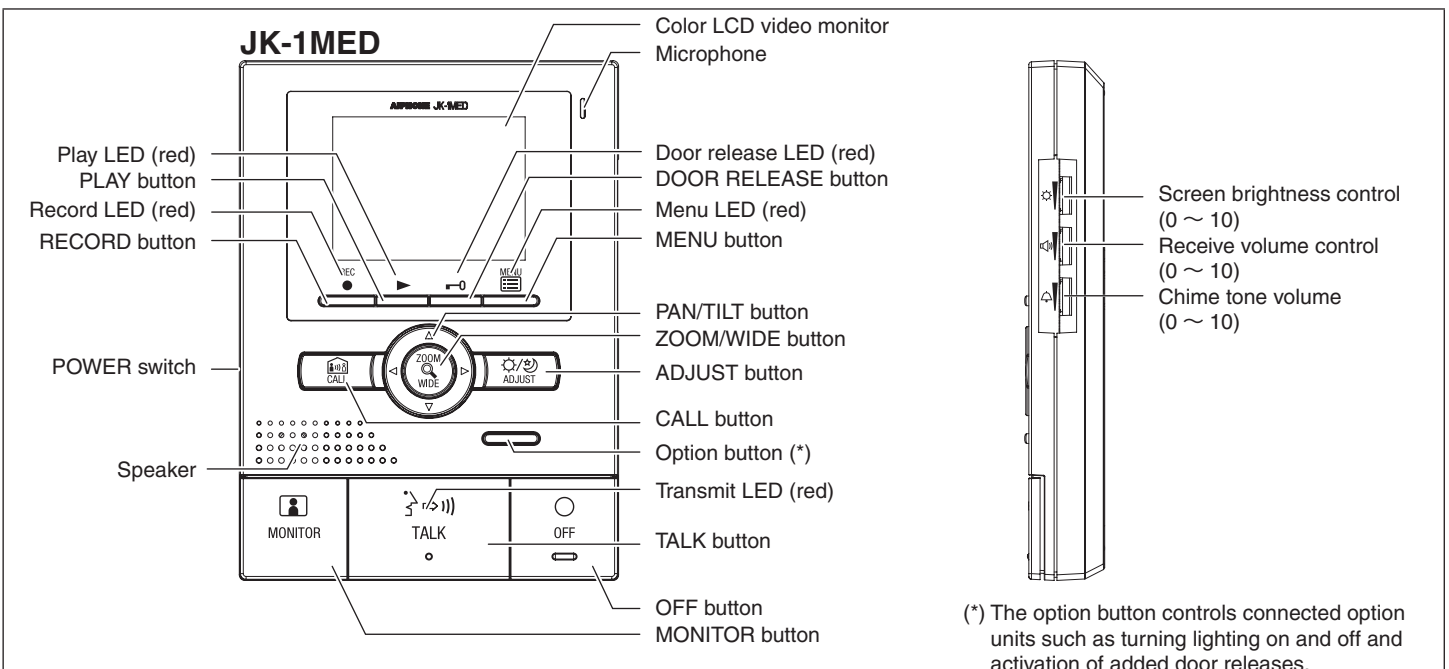

# 6 OPERATING METHOD

To operate this unit, check the symbol and then press the appropriate operation button. This is not a touch-panel operation.

**⚠** Do not press on the LCD or subject it to high impact. The LCD glass could break which could result in an injury.

**Symbol**  
The symbols differ according to the symbol screen.

**Operation buttons:**  
Press to select the symbol that is displayed on the screen.  
\* The name of the operation button may differ from the name of the symbol.

To operate a symbol, press the operation button that is below the symbol.  
Example: To activate manual recording, press **REC** button below the symbol.  
\* In the manual, an explanation is given using the **REC** button ( ).

## Main symbols and function descriptions

Symbol	Function description
	To manually record.
	To return to the screen of the previous operation.
	To display the previous (more recent date) picture.
	To play the recorded pictures.
	To display the next (older date) picture.
	To save or erase an image.
	To erase a recorded image.
	To fast forward the play screen.
	To pause the play screen.
	To advance the play screen frame by frame.
	To reverse the play screen frame by frame.
	To erase the display.
	To save recorded pictures.

※ Setting can also be done by pressing **ZOOM/WIDE** button.

# 7 SETTING UP

**⚠** Upon initial installation, set the time first. If the unit is used without setting the time, the menu LED (red) will light up as notification. When power has not been supplied for at least 3 hours, the time setting will return to the initial setting and the menu LED may flash. Reset the time again.  
If there are no operations for approximately 1 minute during the setup mode, the setting will end automatically. If the settings are incomplete, start again from the beginning.

## 7-1 Setting screens and display methods

**1** In the standby mode, press **MENU** button until the setting screen is displayed (approximately 1 second).

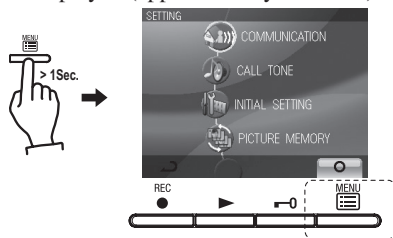

**2** Press **▲** button or **▼** button to select "INITIAL SETTING", and press **MENU** button ( ).

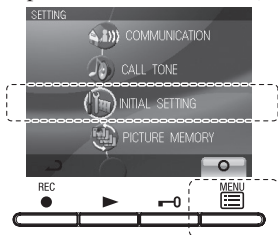

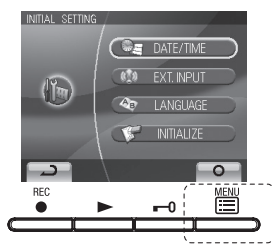

**3** Press **▲** button or **▼** button to select the item you want to set or check, and set with the **MENU** button ( ).



SET THE DATE/TIME	To set the year, date, and time.
SET EXTERNAL INPUT SETTING	To set the external input.
SELECT THE LANGUAGE	To select the language used.
RESTORE DEFAULT SETTING	To initialize the settings.

**4** When completing the time setting, press **OFF** button to return to the standby mode. In other cases, set by pressing **MENU** button ( ). Press **REC** button ( ) to cancel the setting and return to the previous screen.

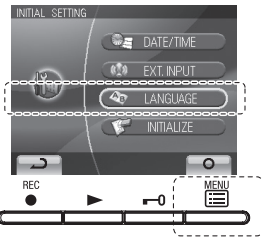

## 7-2 SELECT THE LANGUAGE

- 1 After performing steps 1 and 2 in section 7-1, select "LANGUAGE" in the "INITIAL SETTING" screen and press  MENU button (  ).

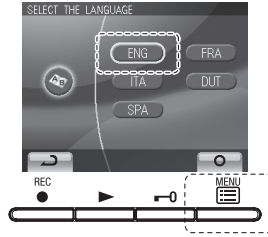

- 2 In the "SELECT THE LANGUAGE" screen, press "▲", "▼", "◀", and "▶" buttons to select the language.



- 3 Press  MENU button (  ) to complete the settings and return to the "INITIAL SETTING" screen.

## 7-3 SET THE DATE/TIME

- 1 After performing steps 1 and 2 in section 7-1, select "DATE/TIME" and press  MENU button (  ).

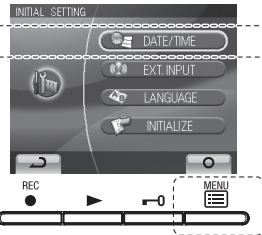

- 2 In the "ADJUST DATE/TIME" screen, press ▲ button or ▼ button to select the "Month".

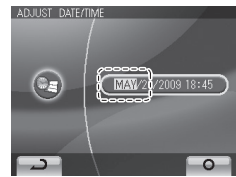

- 3 Pressing ▶ button sets the "Month" and moves the cursor to "Day".

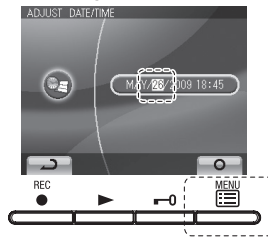

- 4 Perform the same steps to set "Day", "Year", "Hour" and "Minute". After setting "Minute", press  MENU button (  ) to complete the settings.

- 5 Press  OFF button to return to standby mode.

1. If there are no operations for approximately 1 minute during the setup mode, the setting will end automatically. If the settings end while incomplete, start again from the beginning.
2. A maximum error of  $\pm 60$  seconds can occur in the displayed time over a month. Periodically adjusting the time setting is recommended.
3. When power is not supplied to the unit for a long time, the time returns to its initial setting of "JAN/01/2009 00 : 00", and the menu LED (red) will flash as a notification. Reset the time.

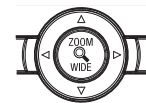

### NOTES: Operations for setting numbers

- ▲ button (press once): The date/time increases by one.
- ▼ button (press once): The date/time decreases by one.
- ◀ button (press once): The cursor moves to the left.
- ▶ button (pressed once): The cursor moves to the right.
- ▲ button (press and hold for 1 second or more.): The date or time increases in succession.
- ▼ button (press and hold for 1 second or more.): The date or time decreases in succession.
-  MENU button: Confirm the setting.



## 7-4 SELECT CALL TONE



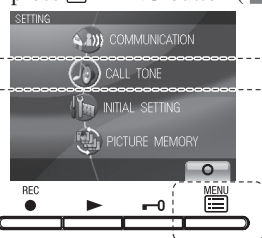

The chime tone for the video door station can be selected from 4 sound types. The initial setting is  1.

- 1 After performing step 1 in section 7-1, select "CALL TONE" and press  MENU button (  ).

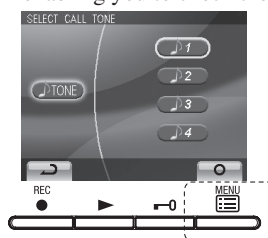

- 2 In the "SELECT CALL TONE" screen, press ▲ button or ▼ button to select the desired chime tone. The selected chime tone sounds, enabling you to check the sound.



- 3 Press  MENU button (  ) to complete the settings and return to the "SETTING" screen. Press  REC button (  ) to cancel the setting and return to the previous screen.



## 7-5 EXTERNAL INPUT SETTING

When optional units operate (for example, when a sensor is activated or call button is pressed), the master monitor station and sub master station will receive an alert sound. Also, when notification at door is enabled, the door station also receives an alert sound.

⚠ These operations must be performed by an installer. Please do not change these settings yourself.

### 7-5-1 : Setting the optional units detection method.

Initial setting : N/O

- 1 After performing steps 1 and 2 in section 7-1, select "EXT. INPUT" and press MENU button ( ).

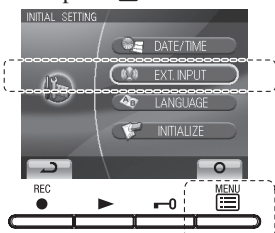

- 2 In the "EXTERNAL INPUT SETTING" screen, press ▲ button and ▼ button to select "DETECTION METHOD" and press MENU button ( ).

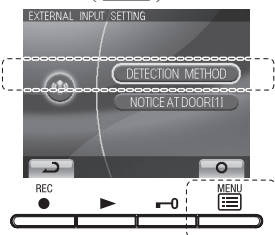

- 3 In the "EXTERNAL INPUT DETECTION METHOD" screen, press ▲ button or ▼ button to select the detection method.

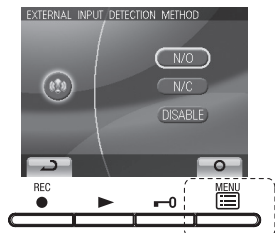

N/O : dry closure contact input  
 N/C : dry closure contact input  
 DISABLE : External input disabled

- 4 Press MENU button ( ) to complete the settings and return to the previous screen.

### 7-5-2 : Setting the alert sound time.

Initial setting: Notification at door disabled/alert sound is 30 sec.

- 1 In the "EXTERNAL INPUT SETTING" screen, press ▲ button or ▼ button to select "NOTICE AT DOOR [1]" and press MENU button ( ).

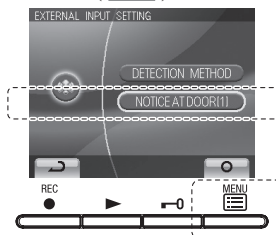

- 2 In the "NOTIFICATION AT DOOR SETTING" screen, press ▲ button or ▼ button to select the "Notification method".

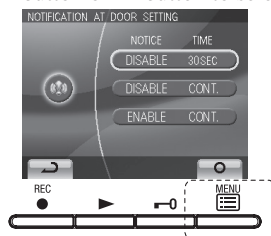

DISABLE 30SEC : Notification at door disabled/alert sound is 30 sec.  
 DISABLE CONT. : Notification at door disabled/alert sound is continuous  
 ENABLE CONT. : Notification at door enabled/alert sound is continuous

- 3 Press MENU button ( ) to complete the settings and return to the previous screen. Press REC button ( ) to cancel the setting and return to the previous screen.

## 7-6 Setting communication time

Select the door station communication time from "1 min.", "2 min.", "3 min.", and "5 min.". Communication time initial setting: "1 min."

- 1 After performing step 1 in section 7-1, select "COMMUNICATION" and press MENU button ( ).

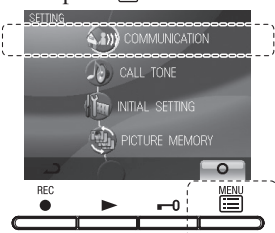

- 2 In the "COMMUNICATION SETTING" screen, press ▲ button or ▼ button to select "COMM. TIME" and press MENU button ( ).

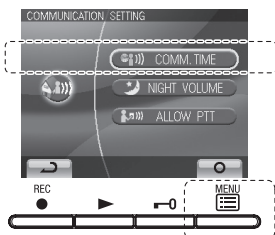

- 3 In the "COMMUNICATION TIME-OUT SETTING" screen, press ▲ button or ▼ button to select the communication time.

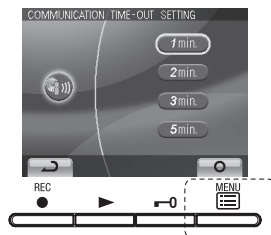

- 4 Press MENU button ( ) to complete the settings and return to the previous screen. Press REC button ( ) to cancel the setting and return to the previous screen.

## 7-7 Automatic night volume adjustment

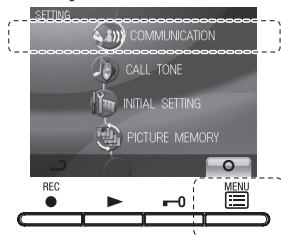

This automatically lowers the communication volume at the door station only at night. Initial setting: "Disabled"

- 1 After performing step 1 in section 7-1, select "COMMUNICATION" and press  MENU button (  ).



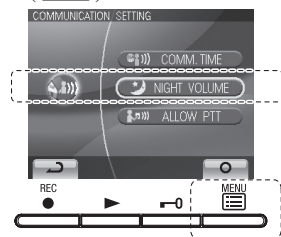



- 2 In the "COMMUNICATION SETTING" screen, press  button or  button to select "NIGHT VOLUME" and press  MENU button (  ).

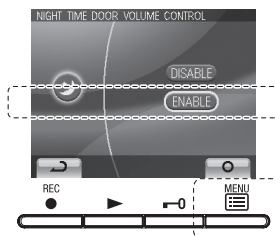

- 3 In the "NIGHT TIME DOOR VOLUME CONTROL" screen, press  button or  button to select "ENABLE".



- 4 Press  MENU button (  ) to complete the settings and return to the previous screen.

Press  REC button (  ) to cancel the setting and return to the previous screen.





NOTES: Distinguishing between day and night is automatically done by the door station.

## 7-8 Restore default setting

All settings can be restored to their condition at the time of purchase.

1. Recorded pictures are erased and settings are reset.
2. Pre-set functions (section 8-7) are not reset.



Settings reset with "RESTORE DEFAULT SETTING"

Setting name	Available setting	
Time	JAN/01/2009 00 : 00	
Language	ENG FRA ITA DUT SPA	
Door station chime tone	 1 (Tone 1)  2 (Tone 2)  3 (Tone 3)  4 (Tone 4)	
Communication time	1 min. 2 min. 3 min. 5 min	
Automatic night volume adjustment	Enable <input type="checkbox"/> Disable <input checked="" type="checkbox"/>	
External input	Detection	N/O N/C Disable
	Notification at door	OFF OFF ON
	Sound time	30 sec. Continuous Continuous
Press-to-talk setting	Enable <input type="checkbox"/> Disable <input checked="" type="checkbox"/>	
Recording	Pictures	• All saved pictures are erased.
	Screen	• Zoom x 3, Wide x 3 • Wide x 3, Zoom x 3 • Zoom x 6 • Wide x 6

\*  are initial views

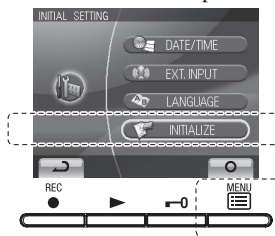
- 1 After performing steps 1 and 2 in section 7-1, select "INITIALIZE" with  or  and press  MENU button (  ).



- 2 In the "INITIALIZE" screen, press  MENU button (  YES ) (approximately 1 sec.) to initialize. Press  REC button (  NO ) to cancel initialization and return to the "MENU" screen.

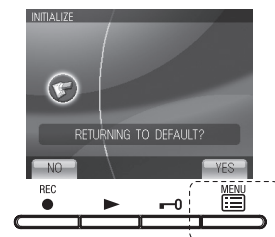

- 3 4 LEDs light up during initialization. The screen goes out when initialization is complete. (The menu LED flashes)

## 7-9 Press-to-talk setting

This disables the press-to-talk setting during communication with a door station (section 8-1).

Initial setting: **ON** (press-to-talk enabled)

- 1 After performing step 1 in section 7-1, select "COMMUNICATION" and press **MENU** button (  ).

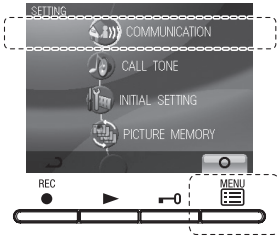

- 2 In the "COMMUNICATION SETTING" screen, press **▲** button or **▼** button to select "ALLOW PTT" and press **MENU** button (  ).

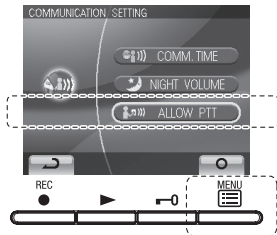

- 3 In the "PTT SETTING" screen, press **▲** button or **▼** button to select **ON** or **OFF**.

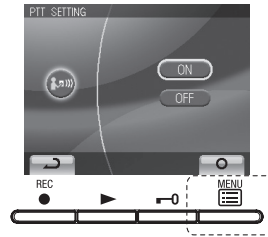

- 4 Press **MENU** button (  ) to complete the settings and return to the "COMMUNICATION SETTING" screen.

## 7-10 Setting picture recording

During automatic recording, select the recording method for recording pictures (up to 6 for each image) from the following four types. The initial setting is for the first three pictures to be zoom pictures at a pre-set position, and for the next three pictures to be wide pictures.

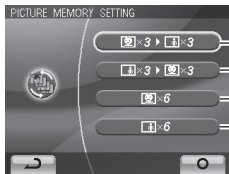

- Pictures are automatically recorded. First three pictures are zoom pictures at a pre-set position, and the next three pictures are wide pictures.
- Pictures are automatically recorded. First three pictures are wide pictures, and the next three pictures are zoom pictures at a pre-set position.
- Pictures are automatically recorded. All six pictures are zoom pictures at a pre-set position.
- Pictures are automatically recorded. All six pictures are wide pictures.

NOTES: The set picture recording method also applies to images displayed during a call from the entrance.

The initial setting is for recording to be done with the first three pictures as zoom pictures at a pre-set position, and the next three pictures as wide pictures.

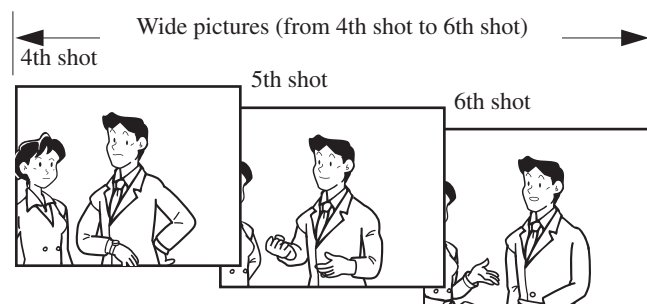
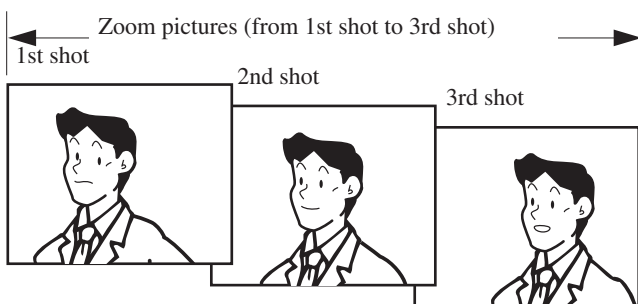

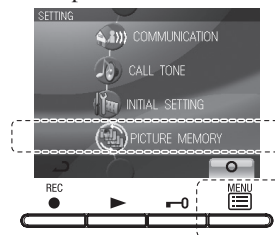

- 1 After performing step 1 in section 7-1, select "PICTURE MEMORY" and press **MENU** button (  ).

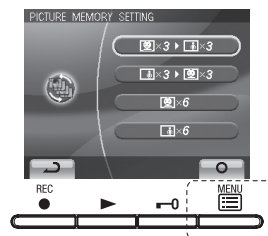

- 2 In the "PICTURE MEMORY SETTING" screen, press **▲** button or **▼** button to select the recording method.



- 3 Press **MENU** button (  ) to complete the settings and return to the "SETTING" screen. Press **REC** button (  ) to cancel the setting and return to the previous screen.

## 8-1 Answering a door call (HANDS-FREE mode, PTT mode)

- 1 Press CALL button.



- 2 Chime tone sounds, caller is seen on video monitor, and outside sound is heard.
- Audio and video turns off after approximately 45 seconds if not answered.

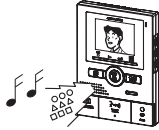

- 3 Press  $\frac{3}{\text{TALK}}$  TALK button momentarily, and after the beep, communicate hands free. Transmit LED (red) lights when you talk, and goes off as you listen to caller (or hear outside sounds).

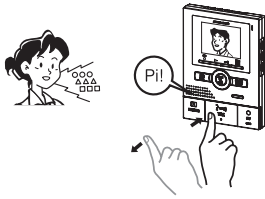

- 4 After finishing communication, pressing  $\frac{0}{\text{OFF}}$  OFF button and communication will end after the beep.

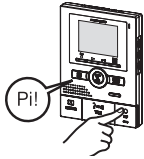

NOTES: 1. Communication (video) ends automatically according to the set communication time. (Refer to section 7-6)  
2. The Transmit LED will light up and go out, but this is not a malfunction.

- ⚠ 1. The screen display will switch automatically according to the picture recording settings (section 7-10).  
⚠ 2. Even if the screen display changes,  $\frac{\text{ZOOM}}{\text{WIDE}}$  ZOOM/WIDE button (section 8-5) can be used to change the display.  
⚠ 3. When  $\frac{3}{\text{TALK}}$  TALK button is pressed momentarily and communication starts, the screen display will be held as is regardless of the picture recording settings.

## Instant voice call function

- 2 Even without answering, door area can be seen and heard with video and audio (for approximately 45 seconds). Inside sound is not heard outside.

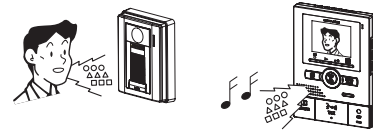

## PTT mode

- 3 Press and hold  $\frac{3}{\text{TALK}}$  TALK button for at least 1 second. A beep sounds, and after approximately 1 second another beep sounds, which indicates PTT mode is engaged. If  $\frac{3}{\text{TALK}}$  TALK button is pressed briefly (less than 0.5 seconds), PTT mode will not be engaged.

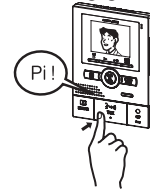

- 4 When communicating, keep  $\frac{3}{\text{TALK}}$  TALK button pressed. To hear the caller's voice, release  $\frac{3}{\text{TALK}}$  TALK button.

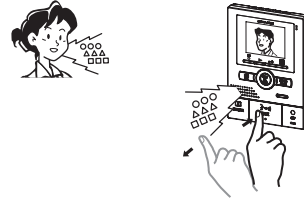

- 5 After finishing communication, press  $\frac{0}{\text{OFF}}$  OFF button and communication will end after the beep.

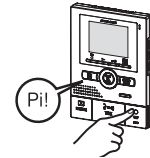

NOTES: When press-to-talk is disabled, PTT mode cannot be used.

## 8-2 Activating door release

- 1 Press  $\frac{0}{\text{DOOR RELEASE}}$  DOOR RELEASE button.

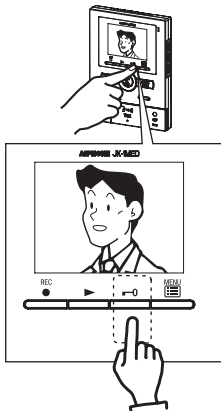

- 2 Open door while the release mechanism is activated. During release: The door release LED (red) lights.

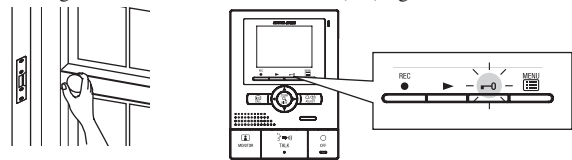

## 8-3 Entrance monitoring

- 1 Press  MONITOR button in the standby mode.

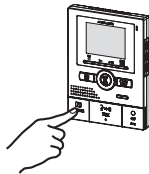





- 2 The video monitor displays the image from the door station and the incoming audio is heard.

If you do not press  TALK button, the caller will not hear sounds from the inside station.



- 3 Press  OFF button to end communication.





NOTES: 1. To talk to the visitor during entrance monitoring, momentarily press  TALK button. This allows communication with the entrance.  
 2. The entrance monitoring turns off automatically after approximately 1 minute. To monitor the entrance again, repeat from the beginning.  
 3. During entrance monitoring, the entrance monitoring time can be extended by approximately 1 min. by pressing  MONITOR button again.  
 4. During entrance monitoring, the display uses a wide picture display. If the  ZOOM/WIDE button is pressed, the display changes to the zoom picture.  
 5. At night, the Illuminator LED will not light up until  TALK button is pressed.  
 6. If another inside unit attempts to perform entrance monitoring while one inside unit is already doing so, a warning beeping sound will occur.

## 8-4 Room-to-room communication

- 1 Press  CALL button to talk with the other person.

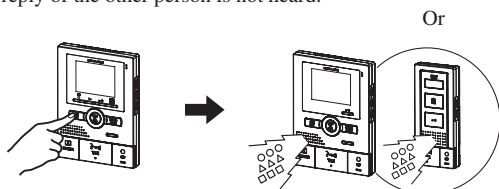
- A call-in is sent to the sub master station.
- The reply of the other person is not heard.



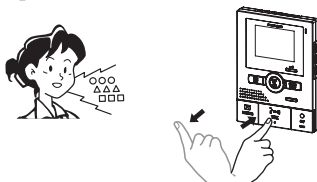

- 2 If the other person presses  TALK button, hands free communication is possible.



- 3 Press and release  OFF button to end communication.



NOTES: 1. Room-to-room communication ends automatically after approximately 10 minutes. To perform room-to-room communication again, repeat from the beginning.  
 2. If a call is received from the entrance during room-to-room communication, the image from the entrance is displayed at the monitor station and sub monitor station where communication is taking place. Press  OFF button to end the room-to-room communication, and press  TALK button to switch to communication with the door station.

## 8-5 WIDE/ZOOM switching

- 1 Press  ZOOM/WIDE button when a picture is displayed.

- Switching between wide  $\leftrightarrow$  zoom occurs each time the button is pressed.

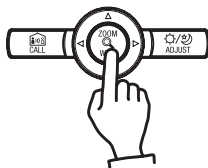

[Wide picture]



[Zoom picture]

NOTES: 1. When the caller is not shown in the center of the picture, the zoom picture can be moved up, down, left, and right. (Refer to section 8-6)  
 2. When the display changes from the wide picture to the zoom picture, the zoom picture starts at the pre-set (section 8-7) position.

 The wide picture may be distorted in comparison with the zoom picture due to the characteristics of the door station camera, but this is not a malfunction.

## 8-6 Pan/tilt operation

1 When a zoom picture is displayed, press ▲, ▼, ◀, or ▶ button.

- [▲] : Up
- [▼] : Down
- [◀] : Left
- [▶] : Right
- Moving diagonally is also possible.

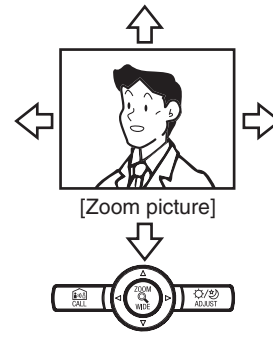
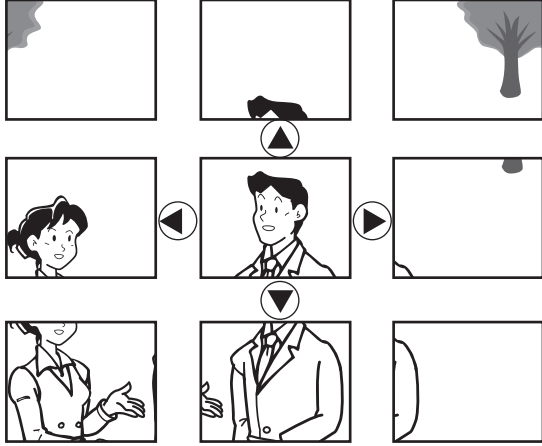
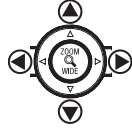

⚠ The image range of the zoom picture and wide picture differs. The edges of the wide picture do not display with the zoom picture.

## 8-7 Zoom Picture Pre-set

The picture can be set to display using a set zoom picture position for when a call is received from the door station. When switching from the wide picture to the zoom picture, the zoom picture displays starting from the pre-set position.

1 When a zoom picture is displayed, press ▲, ▼, ◀, or ▶ button. (Ex. Pressing ▲ button moves the picture up.)

- While viewing the picture, set the desired picture position.

2 Press ZOOM/WIDE button (for at least 2 seconds).

- A beep will sound and the position setting will be completed.

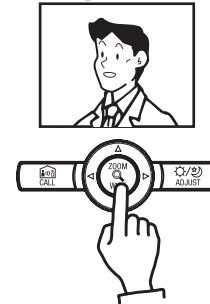

NOTES: 1. To change the zoom picture position that has been set, perform the zoom position setting again. The previous setting will be overwritten.  
2. The zoom picture position set with the master monitor station will also be displayed at the sub monitor station.

## 8-8 Night illumination

At night, the door station Illuminator LED lights up during calling or communication.

8-8-1 When a call is made from the door station

1 If CALL button of door station is pressed

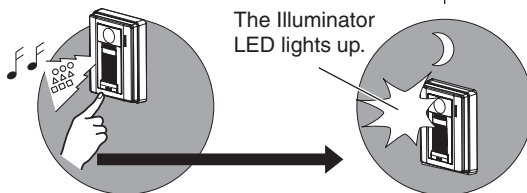

2 When communication ends, the illuminator LED will go out.

8-8-2 Light up the Illuminator LED during entrance monitoring

1 When TALK button is pressed during entrance monitoring, communication starts and the Illuminator LED will light up.

- Inside sound can be heard at the entrance.

⚠ Communication starts at this time, so be aware that inside sound can be heard at the entrance.

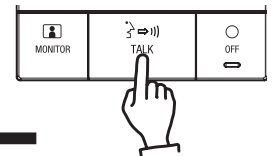



2 When communication ends, the illuminator LED will go out.

NOTES: Distinguishing between day and night is automatically done by the door station.

## 8-9 Backlight adjustment, Night sensitivity adjustment

To perform adjustment

- Press  ADJUST button when the image is difficult to see.
  - Automatic adjustment to a more visible screen is performed. The adjust icon displays at this time.

 : Adjust icon (day)

 : Adjust icon (night)

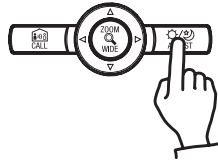
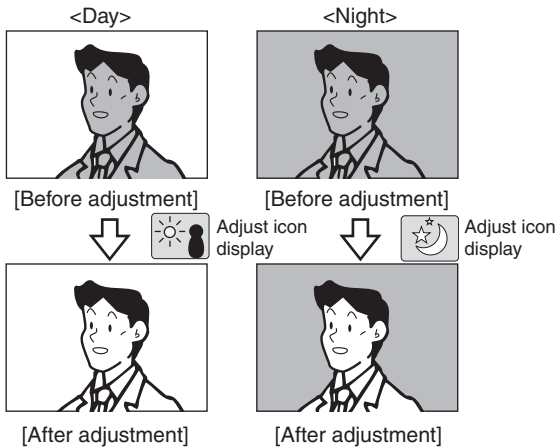

To cancel adjustment

- Press  ADJUST button during adjustment.
  - The adjust icon will disappear and the screen returns to the pre-adjustment screen

NOTES: 1. Distinguishing between day and night is automatically done by the door station.  
2. Pressing  ADJUST button at night makes the caller's face easier to see, but moving subjects may be more difficult to see.

## 8-10 Automatic recording

If a call is received from a video door station, the unit starts recording automatically. The record LED (red) flashes during recording.

- Recording starts approximately 2 seconds after  CALL button of video door station is pressed. A maximum length of approximately 6 seconds (6 shots) can be recorded, with 1 picture and 1 shot for each second.
- A maximum of 40 images can be recorded (combined total of automatic recording and manual recording images). If 40 images are exceeded, images are overwritten starting from the image with the oldest recording date.

NOTES: 1. The automatic recording function cannot be cancelled.  
2. The recorded pictures are recorded using the method (section 7-10) that has been set. However, if switching between zoom and wide is performed during automatic recording, the displayed image will be recorded.  
3. The picture during entrance monitoring is not automatically recorded. If you wish to record this screen, press  REC button.

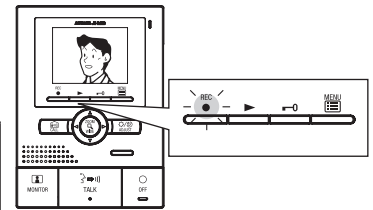

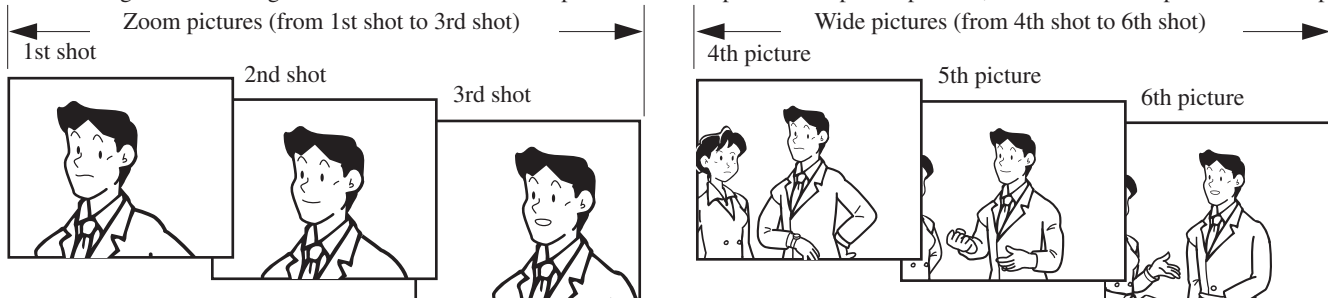

The initial setting is for recording to be done with the first three pictures as zoom pictures at a pre-set position, and the next three pictures as wide pictures.

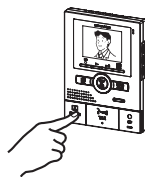

## 8-11 Manual recording

- Display a video image with an operation such as entrance monitoring.



- Press  REC button (  ). The record LED (red) flashes (6 times) and recording starts.

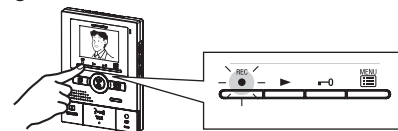

NOTES: 1. Manual recording is not possible during automatic recording (for approximately 7 seconds after receiving a call from the door station).  
2. After the end of automatic recording (approx. 7 seconds after receiving a call from the door station), recording of another image in addition to the automatically recorded image can be performed.  
3. When manual recording, the displayed image is recorded.

- A maximum length of approximately 6 seconds (6 shots) can be recorded, with 1 image and 1 shot for each second.
- A maximum of 40 images can be recorded (combined total of automatic recording and manual recording images). When 40 images are exceeded, new images overwrite old images starting from the oldest recorded date.

## 8-12 Play recorded picture

If there are automatically recorded pictures, such as those taken while you were out, the play LED (red) flashes.

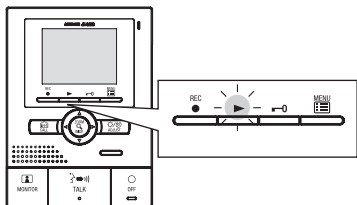

- 1 Press ► PLAY button in standby mode to display the picture with the most recent date. \* [ ] displays on the screen when there are no recorded pictures.

The operation status displays.

Sequence number of image currently being displayed/total recorded images

Displayed when image is unread.

Displays when image is saved.

07/16 ★ JAN/01/2009 18:45

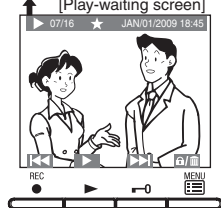

Time and date of recording

- 2 Press ► PLAY button (►) on the play-waiting screen. The recorded image is played. When the play of one image ends, the next image is displayed.

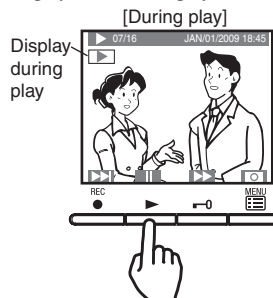

Display during play



- 3 To advance the play screen frame-by-frame, press ► PLAY button (▢) during playback to pause. The play moves forward frame-by-frame each time ► DOOR RELEASE button (►) is pressed. When the frames of one image end, the next picture is displayed.

- 4 Press OFF button to end.

\* In the manual, screen icons and button icons are explained together.

\* In addition, the operations shown below are also possible in the play screen.

- REC button (◀▶):  
To display the previous (more recent date) picture. When the button is pressed for 1 second or more, during the time that the button is pressed the first picture only of the dates can be checked in succession, from older to more recent dates. (If REC button is pressed while the picture with the most recent date is displayed, the picture with the oldest date will display.)
- DOOR RELEASE button (▶):  
To display the next (older date) picture. When the button is pressed for 1 second or more, during the time that the button is pressed the first picture only of the dates can be checked in succession, in the direction of the older dates.
- MENU button (☰):  
To save or erase an image. (Refer to sections 8-13 and 8-14)

1. When there are multiple unread images, all images enter the "read" condition even if only one image is played, and the play LED goes off.
2. The recorded pictures are displayed in order based on the date set during recording.

\* The operations shown below are possible during play.

- MENU button (☰):  
The pictographic display on the screen can be erased.
- PLAY button (▢):  
To pause play.
- DOOR RELEASE button (▶):  
To display the picture with the next oldest date after fast forward playing.

\* In addition, the operations shown below are also possible during pause.

- REC button (◀▶):  
The play is reversed frame by frame each time the button is pressed. When the frames of one image end, the unit returns to the play-waiting screen.
- PLAY button (▶):  
To return to the play screen.
- MENU button (☰):  
Pressing the button displays the picture with the next oldest date in the play-waiting screen.

- NOTES: 1. If there are no operations for at least approximately 1 minute, it will end automatically.  
2. If a call is received from a door station during play, the chime tone sounds and the play is forcibly ended.

## 8-13 Save recorded picture

10 images can be saved from the recorded images (maximum of 40 images). Saved pictures are not overwritten.

- 1 Display the picture that you want to save in the play-waiting screen. (Refer to section 8-12)

Press MENU button (☰) to display the save/erase selection screen.



- 2 Press ► PLAY button (☰/☒). If the image is saved, the key symbol is displayed. If the image has already been saved, the save is canceled. Each time ► PLAY button (☰/☒) is pressed, the operation switches between save and cancel.

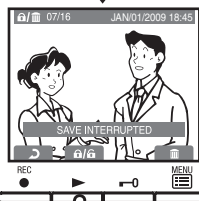

\* In addition, the operations shown below are also possible in the save/erase selection screen.

- MENU button (☰):  
To erase the display picture. (Refer to section 8-14)
- REC button (▶):  
To return to the play-waiting screen.

- NOTES: 1. "CANNOT SAVE" is displayed if the number of possible saves is exceeded. Cancel unnecessary saved image.  
2. Images that have had the save canceled are not erased, but they are overwritten if the number of recorded images is exceeded.



# Warranty

English

Aiphone warrants that its products have no material or workmanship defects under normal use conditions for two years after delivery to the end user. Aiphone will perform repair or replacement free of charge if the product is defective and the warranty applies to the defect. Aiphone reserves unto itself the sole right to make the final decision whether there is a defect in materials and/or workmanship and whether or not the product is under warranty. This warranty shall not apply to any Aiphone product which has been subject to misuse, neglect, accident, or to use in violation of instructions furnished, nor extended to units which have been repaired or altered outside of the factory. This warranty does not cover batteries or damage caused by batteries used in connection with the unit. This warranty only includes carry-in repairs. Any repairs must be made at the shop or place designated in writing by Aiphone. Aiphone will not be responsible for any costs incurred during on-site service calls. Aiphone will not provide compensation for any loss or damage incurred by the breakdown or malfunction of its products during use, or for any consequent inconvenience or losses that may result.

The object area of  is the EU.

# Garantie

Français

Aiphone garantit que ce produit ne présente pas de défaut matériel ou de fabrication dans des conditions normales d'utilisation pendant les deux années suivant la livraison à l'utilisateur final. Aiphone en effectuera gratuitement la réparation ou le remplacement si le produit est défectueux et que la garantie s'applique pour le défaut. Aiphone se réserve le droit exclusif de décider s'il existe ou non un défaut de matière ou de fabrication et si l'appareil est ou non couvert par la garantie. Cette garantie ne s'applique pas à tout produit Aiphone qui a été l'objet d'une utilisation impropre, de négligence, d'un accident ou qui a été utilisé en dépit des instructions fournies; elle ne couvre pas non plus les appareils qui ont été réparés ou modifiés en dehors de l'usine. Cette garantie ne couvre pas les piles ni les dégâts infligés par les piles utilisées dans l'appareil. Cette garantie comprend uniquement les réparations en atelier. Toutes les réparations doivent être réalisées à l'atelier ou au site désigné par écrit par Aiphone. Aiphone décline toute responsabilité en cas de frais encourus pour les dépannages à domicile. Aiphone n'indemniser pas le client en cas de pertes, de dommages ou de désagréments causés par une panne ou un dysfonctionnement d'un de ses produits.

La zone d'application de  est l'UE.

# Garantie

Nederlands

Aiphone garandeert dat zijn producten onder normale gebruiksomstandigheden gedurende twee jaar na levering aan de eindgebruiker vrij zijn van materiaal- of fabricagefouten. Aiphone zal het product kosteloos herstellen of vervangen als het defect is en de garantie van toepassing is op het defect. Aiphone behoudt zich het recht voor om als enige definitief te bepalen of er al dan niet sprake is van een materiaal- en/of fabricagefout; en of het product nog onder garantie is. Deze garantie geldt niet voor een Aiphone-product dat is blootgesteld aan verkeerd gebruik, verwaarlozing, een ongeval of verkeerde bediening en evenmin voor toestellen die buiten de fabriek zijn hersteld of gewijzigd. Deze garantie geldt niet voor batterijen of schade veroorzaakt door batterijen die in het toestel zijn gebruikt. Deze garantie geldt uitsluitend voor herstellingen die worden ingeleverd en opgehaald door de klant. Alle herstellingen moeten worden uitgevoerd in de winkel of op de plaats die schriftelijk is aangeduid door Aiphone. Kosten die gepaard gaan met herstellingen ter plaatse kunnen niet worden verhaald op Aiphone. Er kan geen schadeloosstelling van Aiphone worden geëist voor enig verlies of schade als gevolg van een defect of storing tijdens het gebruik van zijn producten, of voor enig ongemak of verlies dat hieruit voortvloeit.

Het toepassingsgebied van  is de EU.

This equipment has been tested and found to comply with the limits for a Class B digital device, pursuant to Part 15 of the FCC Rules. These limits are designed to provide reasonable protection against harmful interference in a residential installation. This equipment generates, uses, and can radiate radio frequency energy, and if not installed and used in accordance with the instructions, may cause harmful interference to radio communications. However, there is no guarantee that interference will not occur in a particular installation. If this equipment does cause harmful interference to radio or television reception, which can be determined by turning the equipment off and on, the user is encouraged to try to correct the interference by one or more of the following measures: · Reorient or relocate the receiving antenna · Connect the equipment into an outlet on a circuit different from that to which the receiver is connected. Increase the separation between the equipment and receiver. · Consult the dealer or an experienced radio/TV technician for help.



*Providing Peace of Mind*

<http://www.aiphone.com/>

AIPHONE CO., LTD., NAGOYA, JAPAN  
AIPHONE CORPORATION, BELLEVUE, WA, USA  
AIPHONE S.A.S., LISSES-EVRY, FRANCE

Printed in Thailand