

AIPHONE

JK-DVF-AC

**Vandal-resistant Color Video Door Station
with Access Control Keypad**

**Platine vidéo couleur résistante au vandalisme
avec clavier à codes rétro-éclairé**

**Antivandalisme deurpost met kleurencamera en
ingebouwd codeklavier**

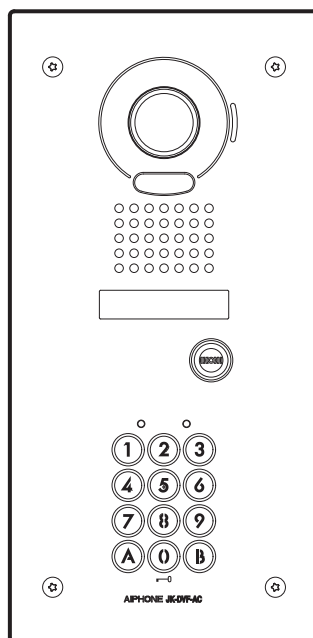

JK-DVF-AC

**INSTALLATION & OPERATION MANUAL
MANUEL D'INSTALLATION ET D'UTILISATION
INSTALLATIE & GEBRUIKSHANDLEIDING**

**RECORD OF SETTINGS AND REGISTRATION DETAILS FOR ACCESS CONTROL
(Please make sure to write down your settings below.)**

**AIDE MEMOIRE DES PROGRAMMATIONS ENREGISTREES POUR LE CLAVIER
(Faire en sorte de bien noter vos réglages ci-dessous.)**

**LIJST MET GEPROGRAMMEERDE INSTELLINGEN EN CODES VOOR
CODEKLAVIER (Zorg ervoor uw instellingen hieronder op te schrijven.)**

Master code Code maître Hoofdcode			
Key illumination time Temporisation d'éclairage Verlichtingsduur klavier			SEC
Relay output time Temporisation des relais Relais outputtijd	Relay 1 Relais 1 Relais 1		SEC
	Relay 2 Relais 2 Relais 2		SEC

External output setting Paramétrage de sortie externe Activering Alarmuitgang	<input type="checkbox"/> ON AAN	/	<input type="checkbox"/> OFF UIT
Lockout Blocage Blokking klavier	<input type="checkbox"/> ON AAN	/	<input type="checkbox"/> OFF UIT
Auto-relock Auto-reverrouillage Automatische hersluiting	<input type="checkbox"/> ON AAN	/	<input type="checkbox"/> OFF UIT
Timer-linked unlocking Déverrouillage lié à l'horloge Tijdsgebonden ontgrendeling	<input type="checkbox"/> 1	<input type="checkbox"/> 2	<input type="checkbox"/> 1&2
Operation tone Bip de fonctionnement Zoemer klavier	<input type="checkbox"/> ON AAN	/	<input type="checkbox"/> OFF UIT

Registered User Code List / Liste des codes utilisateur programmés / Lijst Codes Geregistreeerde Gebruikers

group 1 / groupe 1 / groep 1				
00				
01				
02				
03				
04				
05				
06				
07				
08				
09				
10				
11				
12				
13				
14				
15				
16				
17				
18				
19				
20				
21				
22				
23				
24				
25				
26				
27				
28				
29				

group 2 / groupe 2 / groep 2				
60				
61				
62				
63				
64				
65				
66				
67				
68				
69				
70				
71				
72				
73				
74				
75				
76				
77				
78				
79				
80				
81				
82				
83				
84				
85				
86				
87				
88				
89				

Thank you for selecting Aiphone for your communication and security needs. Please read this manual carefully before installation, and keep it in a safe place for future reference.

* Refer to the "INSTALLATION & OPERATION MANUAL" for the JK-1MED or JK-1MD for complete information regarding this system.

PRECAUTIONS

- ⊘ General Prohibitions
- ⊘ Prohibition to Dismantle the Unit
- ⓘ General Precautions

WARNING

(Negligence could result in death or serious injury to people)

- ⊘1. The unit must be installed and wired by a qualified technician. Having installation performed by an unqualified technician could result in electric shock.
- ⊘2. Do not connect any non-specified power source to the V, V terminals, and do not install two power supplies in parallel to a single input. Fire, damage to the unit, or system malfunction could result.
- ⊘3. The unit is not explosion-proof. Do not install or use near gases or flammable materials. Fire or explosion could result.
- ⊘4. Do not dismantle or alter the unit. Fire or electric shock could result.
- ⊘5. Do not allow the wires or DC output terminals to be shorted. Fire or electric shock could result.
- ⓘ6. Existing wiring such as chime wiring, etc. may contain high voltage AC electricity. Damage to the unit or electric shock could result. Wiring and installation should be done by a qualified technician.

CAUTION

(Negligence could result in injury to people or damage to property)

- ⓘ1. When mounting the unit on a wall, install the unit in a convenient location, but not where it could be jarred or bumped. Injury could result.
- ⓘ2. Do not install or make any wire terminations while power supply is plugged in. It can cause electrical shock or damage to the unit.
- ⓘ3. Before turning on power, make sure wires are not crossed or shorted. Fire or electric shock could result.

- ⊘4. Do not install the unit in any of the following locations. Fire, electric shock, or unit trouble could result.
 - * Places subject to dust, oil, chemicals, hydrogen sulfide (hot spring).
 - * Places subject to moisture and humidity extremes, such as bathroom, cellar, greenhouse, etc.
 - * Places where the temperature is quite low, such as inside a refrigerated area or in front of air-conditioner.
 - * Places subject to steam or smoke (near heating or cooking surfaces).
 - * Where noise generating devices such as dimmer switches, inverter electrical appliances, are closeby.
- ⊘5. Do not put anything on the unit or cover the unit with cloth, etc. Fire or unit trouble could result.

GENERAL PRECAUTIONS





1. This product, being a control unit of door release, should not be used as a crime-prevention device.
2. This product is weather-resistant, but do not spray high-pressure water on it. Unit trouble could result.
3. The product becomes inoperative during power failure.
4. As to other manufacturer's devices, such as sensor, door releases, timer, used with this system, comply with the Specifications and Warranty conditions manufacturers or venders present.
5. When outside temperature lowers sharply after rainfall, etc., the inside of the camera may fog up slightly, causing a blurry picture, but this is not a malfunction. Normal operation will be restored when moisture evaporates.
6. Due to the environmental sound around the unit, it may hinder smooth communication, but this is not a malfunction.

CONTENTS

RECORD OF SETTINGS AND REGISTRATION	
DETAILS FOR ACCESS CONTROL.....	1
PRECAUTIONS	2
PACKAGE CONTENTS	3
MOUNTING	3
PART NAMES	4

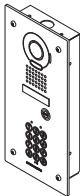
WIRING AND CONNECTIONS	5
FUNCTIONS/SETTING UP FOR ACCESS CONTROL...	7
OPERATION OF ACCESS CONTROL.....	11
TECHNICAL PRECAUTIONS	11
SPECIFICATIONS	12
WARRANTY	12

PACKAGE CONTENTS

Door station with Flush mount back box	Special screwdriver	Transparent nameplate (x2)	Installation & Operation manual
			

MOUNTING

Mounting locations

"Do not install this unit in any of the following locations where lighting or the ambient environment could impact the display on the video monitor due to the characteristics of the door station's camera."

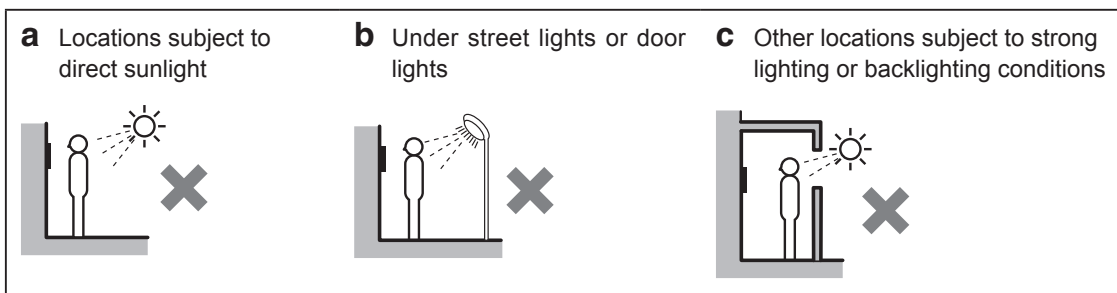

Mounting positions and image view area of Video door station

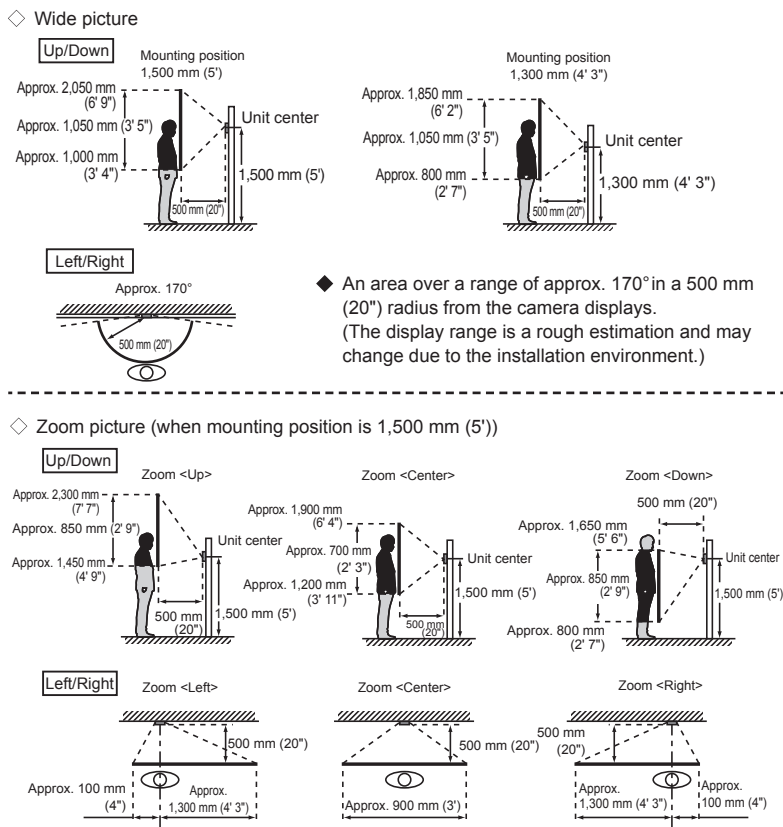
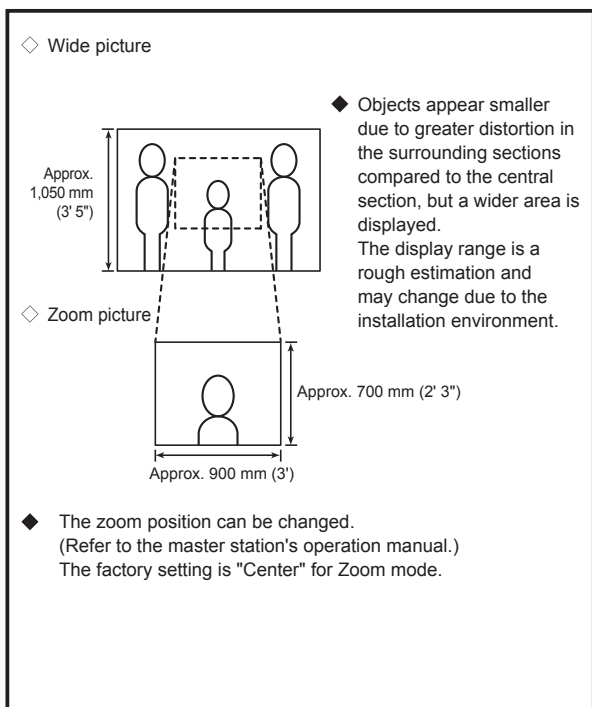

Mounting

1. Detach the door station from the flush mount back box by removing the screws with the special screwdriver that is supplied with the unit.
2. Attach the flush mount back box to the wall.
3. Route wiring through the flush mount back box and connect wires to the door station.
 - * See page 5 and 6 for details on wiring and connections.
4. Attach the door station to the flush mount back box.
 - * Be sure to use the original screws to reattach the door station to the flush mount back box.

Using the transparent nameplates

Inserting the transparent nameplates

- ① Remove the door station from the flush mount back box.
- ② Peel off the protective seals on the plate (both sides).
- ③ Fill in the name of the resident on the transparent nameplate.
 - ⚠ Be sure to leave 25 mm (1") of white space on the left end to account for insertion.
- ④ Insert the filled-in transparent nameplate at the specified insertion opening on the rear side of the door station (indicated with ⇨ in diagram).

Notes on handling wires

- After stripping back the cable jacket from the conductors, waterproof the area that has been cut by wrapping insulation tape around the end of the jacket. Additionally, position the cable downward to prevent rainwater or moisture from seeping into the cable.
- Do not bend the wires at a sharp angle to prevent them from breaking as they age.

PART NAMES

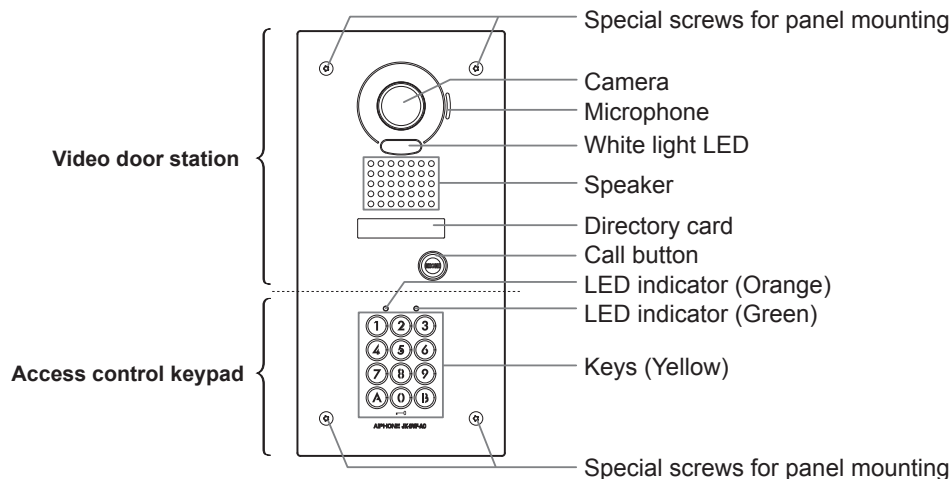

WIRING AND CONNECTIONS

Outline of connections and wiring distance

Wiring distance

	Power supply	Diameter	Distance
A	-	0.65 mm (22 AWG)	50m (165')
	-	1.0 mm (18 AWG)	100m (330')
B	12 - 18V AC or DC or less	0.65 - 1.0 mm (22 - 18 AWG)	100m (330')
	18 - 24V AC or DC	0.65 - 1.0 mm (22 - 18 AWG)	300m (980')
C	-	0.65 - 1.0 mm (22 - 18 AWG)	300m (980')
D	-	The connection distance will depend on the specifications of the electric door strike, relays or electromagnetic door lock to be connected. To determine the operating range, please refer to the specifications of each terminal.	

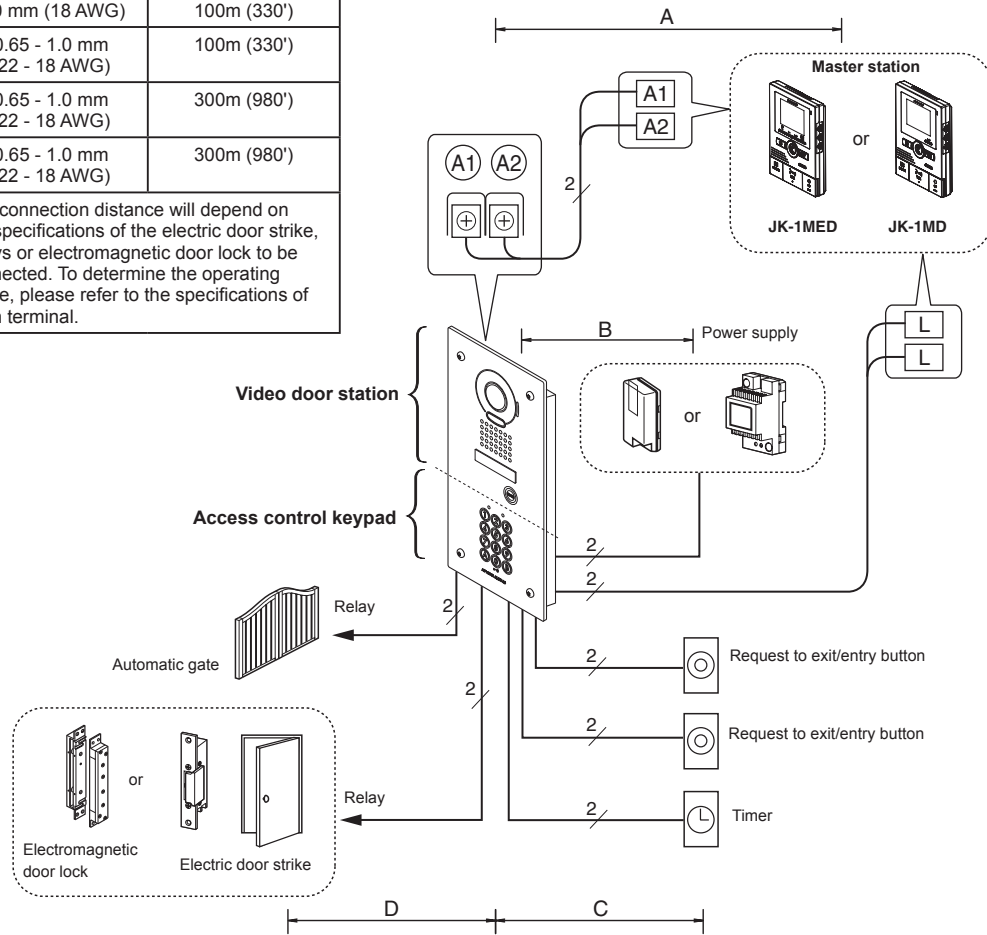

Terminal names

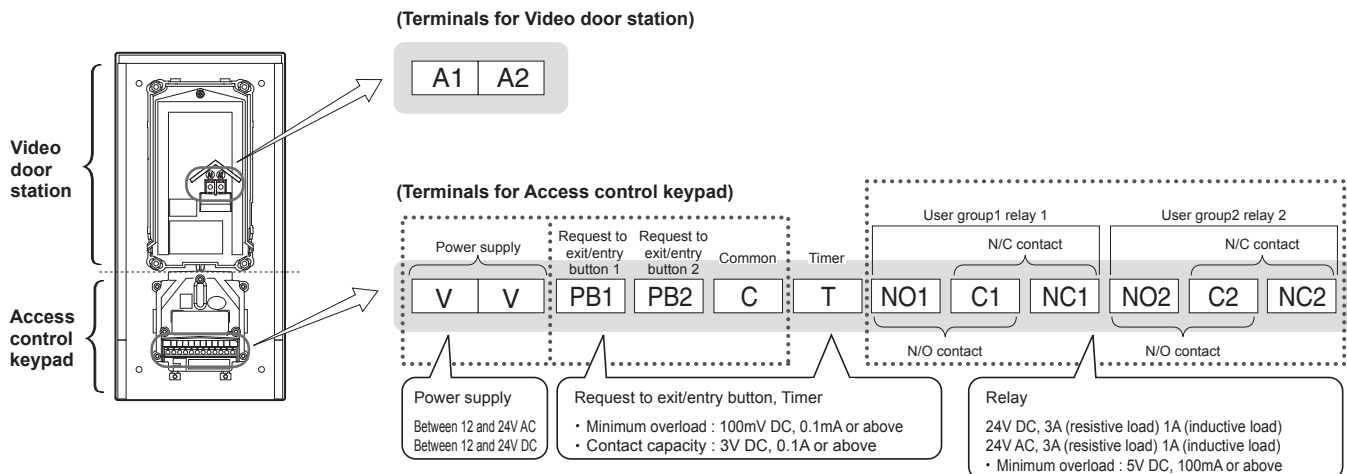

Connection examples

■ Connection of Relay 1 only

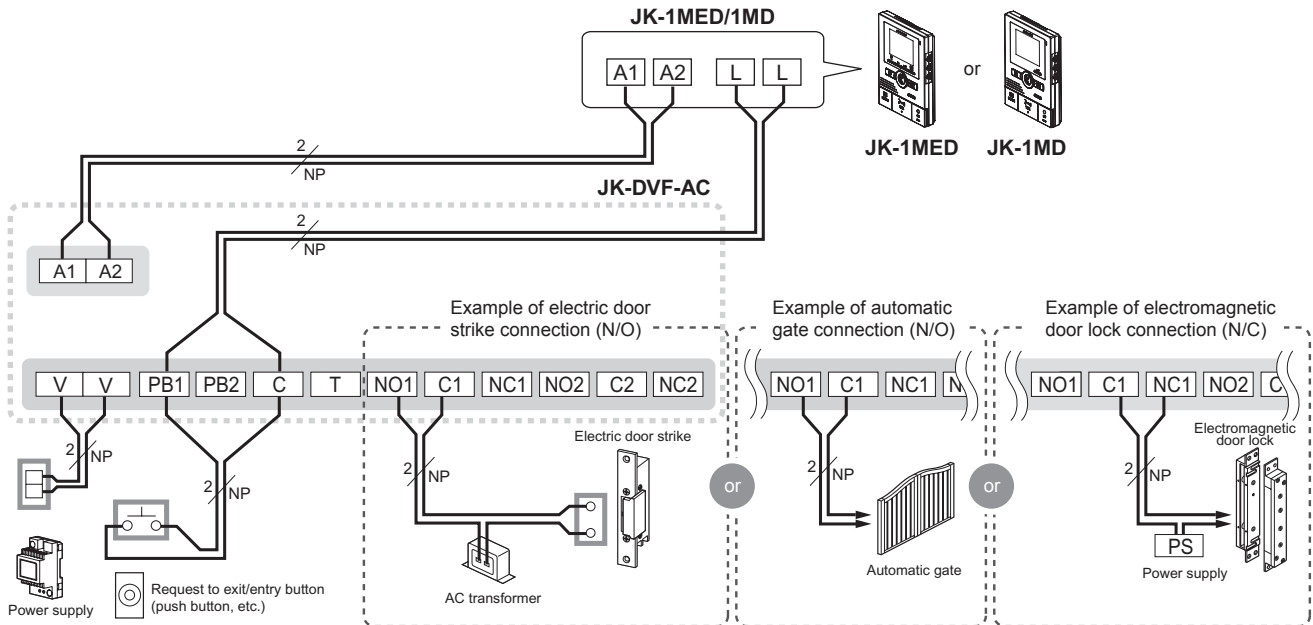

■ Relay 1: Automatic gate (N/O contact), Relay 2: Electric door strike (N/O contact)

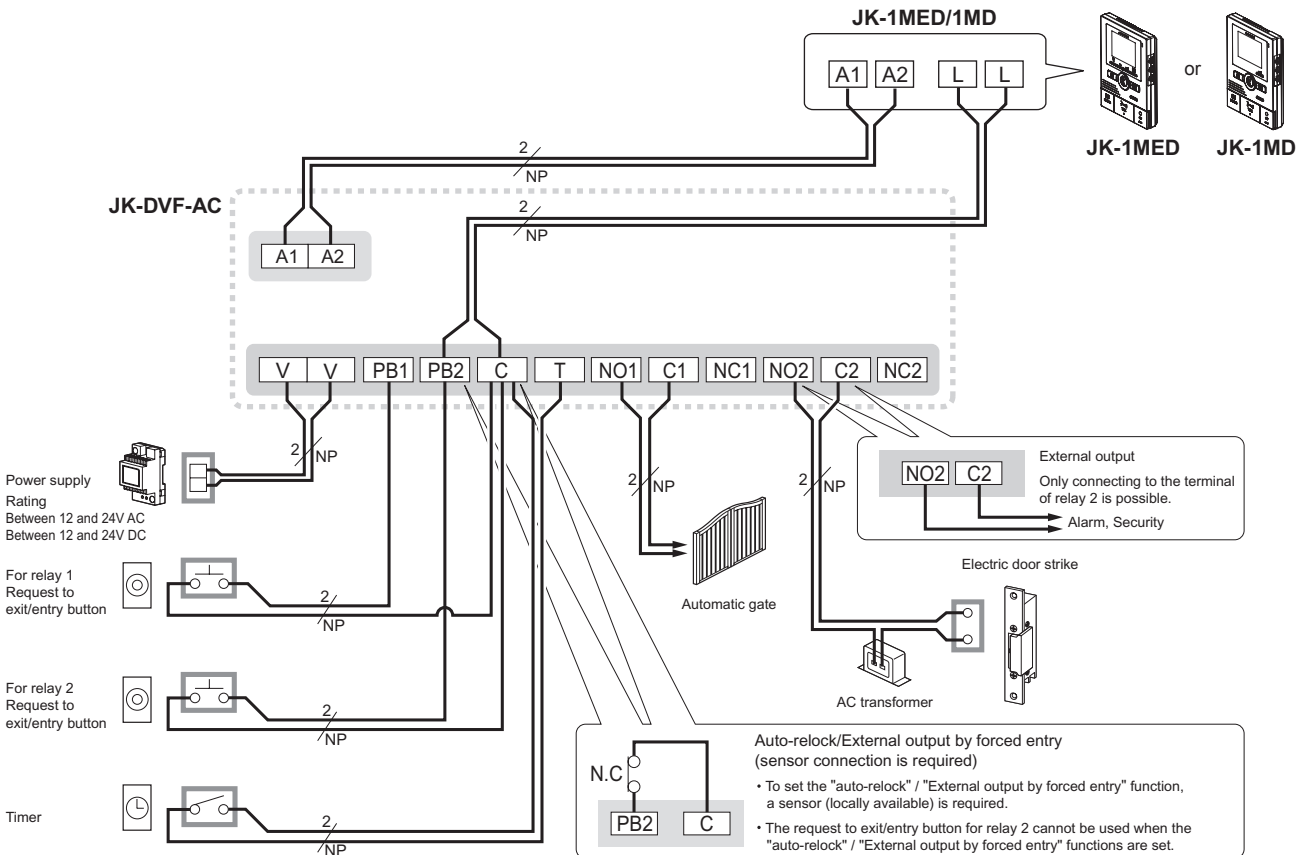

FUNCTIONS/SETTING UP FOR ACCESS CONTROL

This section explains the settings of each function, including the master code for management, the user code for unlocking, the buzzer and the LEDs.

About the setting mode:

Enter master code twice to switch to the setting mode, and enter the following setting code to perform the settings for the desired function. After settings have been made, enter the following setting codes to continue the setting operation. Press (B) to exit the setting mode.

Setting items	Allowable setting range	Default value	Setting code
I Setting the code length Change the length of the master code and the user code. ※) They both must be the same length.	4, 5, or 6 digits	4 digits	(A) (3)
II Setting the master code Enter a master code using between 4 and 6 digits (alpha or numeric) to switch to the setting mode. ※) The number of digits in the code can be set by setting the code length.	1 Valid keys: 0 - 9, A, B	1234	(A) (4)
III Setting the code for user group 1 Set the unlocking code for user group 1. ※) The number of digits in the code can be set by setting the code length.	Number of codes: 60 Valid keys: 0 - 9, A, B	-	(0) (0) - (5) (9)
Setting the code for user group 2 Set the unlocking code for user group 2. ※) The number of digits in the code can be set by setting the code length.	Number of codes: 40 Valid keys: 0 - 9, A, B	-	(6) (0) - (9) (9)
IV Setting the key illumination time Set the length of time that the keys will be lit up after they are pressed.	Illumination time: 10 to 99 seconds, or continually lit	10 Sec.	(A) (0)
V Setting the relay 1 output time Set the output time of relay 1.	Output time: 1 to 99 seconds, or latched	3 Sec.	(A) (1)
V Setting the relay 2 output time Set the output time of relay 2.	Output time: 1 to 99 seconds, or latched	3 Sec.	(A) (2)
VI Reset Settings Return all the settings to their default values.	-	-	(A) (5)
VII External output setting The alarm or security system connected to the terminal of relay 2 will be activated when the "Lockout" * or the forced entry* is carried out. * "Lockout": Refer to VIII below. *Forced entry: This function is linked with the door open/close sensor (N.C.) which is connected to PB2 and C, and carried out when opening the door without activating this unit. (For example, entry in an improper manner, manual unlock, etc.) ※) If there is a way to open the door without activating this unit, such as manual unlock, do not make the external output setting for the forced entry.	· OFF · During Lockout · During forced entry output · During lockout and forced entry output	OFF	(A) (6)
VIII Lockout If several incorrect access codes are attempted, the code input function is disabled for a programmed period of time. · When "Lockout" is activated, the LED (Orange) indicator and the keypad blink, and the buzzer sounds for 3 seconds. This is just a sound to inform you that the function has been activated. It is not a warning sound. If you want a warning to be sounded, please use the external output function to activate a commercially-available alarm device. · The unlock function will work when the request to exit/entry button is pushed, even while the "Lockout" function is operating.	ON/OFF Invalid number of times: 10 to 99 times Invalid time: 10 to 99 seconds	OFF	(A) (7)
IX Auto-relock (Anti-tailgate) After the door has been linked to the door open/close sensor (N/C), and unlocked, it will relock itself one second after being closed, thus preventing the entry of an unauthorized third party. ※1	ON/OFF	OFF	(A) (8)
X Timer-linked unlocking setting The system can be set to unlock the door by pressing the (0) key within the set time and linking it to the external timer (N/O). The operations for the LEDs and the buzzer after unlocking are the same as those used to perform user code unlocking. When the door is linked to the timer, unlocking can be performed using the user code and the request to exit/entry button. When latch output is performed for the relay settings, the relay turns ON/OFF every time the (0) key is pressed.	Linked relay: relay 1 relay 2 relay 1 and 2 0 key illumination: ON/OFF	Linked relay: relay 1 0 key illumination: OFF	(A) (9)
XI Operation tone settings Set the tone heard when the keypad is being used to ON/OFF.	ON/OFF	ON	(A) (A)

- The setting can be saved even when the power is off.
- The system cannot be switched to the setting mode while the relay is unlocked.
- When the setting mode has been activated and no operations are performed for approximately 120 seconds, the system will exit the setting mode. (If a key is pressed during that time, the timer will start over.)
- Neither the request to exit/entry button nor the timer-linked unlocking (0) key can be operated, and unlocking using the user code cannot be performed while the setting mode is activated.
- The volume (the check tone, operation tone, etc.) from the door station may become lower according to the mounting status.
 ※1 : When the auto-relock is used, the request to exit/entry button for relay 2 cannot be used. The output of relay 2 is only possible when user code unlocking is performed.

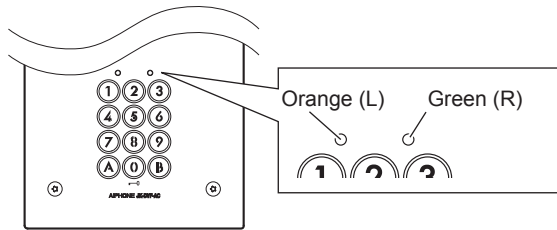

The result of each operation is indicated by the lighting up of the LED indicators located just above the keys, and by the sounding of the buzzer.

Input the master code twice.
(Default: 1 2 3 4 1 2 3 4)

(orange) Illumination (green) Blinking
Bleep, Bleep

I Setting the code length (Default: 4 digits) | **II Setting the master code** (Default : 1234) | **III Setting the code**
group 1 | group 2

<p>Input the setting code. A 3</p> <p>Illumination Blinking Bleep</p>	<p>Input the setting code. A 4</p> <p>Illumination Blinking Bleep</p>	<p>00 - 59 Inputting of user number (ex.: 01) 0 1</p> <p>When a user code that has already been set is selected Illumination Blinking Bleep</p> <p>When a user code that has already been set is selected Illumination Blinks twice Bleep, Bleep</p>	<p>60 - 99 Inputting of user number (ex.: 60) 6 0</p> <p>When a user code that has already been set is selected Illumination Blinking Bleep</p> <p>When a user code that has already been set is selected Illumination Blinks twice Bleep, Bleep</p>
<p>Inputting of code length (ex.: 5 digits) 4, 5, or 6 digits 5</p> <p>Illumination Blinking Bleep</p>	<p>Inputting of new master code (ex.: 4321) 4 3 2 1</p> <p>Illumination Blinking Bleep</p>	<p>Inputting of code (ex.: 1006) * Numbers 0 - 9 and the letters A and B can be used 1 0 0 6</p> <p>Illumination Blinking Bleep</p>	<p>Inputting of code (ex.: 04B2) * Numbers 0 - 9 and the letters A and B can be used 0 4 B 2</p> <p>Illumination Blinking Bleep</p>

- When the **(B)** key is pressed, the green LED lights up, the buzzer beeps twice, and the system exits the setting mode. (If the **(B)** key is included in the user code and the master code, the system does not exit the setting mode.)
- You can continue the setting up operation by entering an arbitrary setting code.

Indicator goes out Blinking
Bleep, Bleep

- The set code will be saved in memory, even if the code length is changed. However, codes of different lengths cannot be used.
- When the code length has been changed, the master code returns to the default value (if the number of digits in the code is 4, 5, or 6, the master code is 1234, 12345, or 123456 respectively).
- Please note that the shift to the setting mode can be performed during timer-linked unlocking. However, if "0" is included in the master code, the door will be unlocked, and the shift to the setting mode will not be able to be performed.
- The same code cannot be set for both the user code and the master code (the previously set code has priority).
- Do not set simple codes, such as 1111.
- We recommend that you change the default master code.
- To make the set user code invalid, press 0000 (when n 4 digits are used), 00000 (when 5 digits are used), or 000000 (when 6 digits are used). Code numbers which contain only "0" cannot be set as user codes.
- As the factory pre-setting master code is 1234, 1234 (when 4 digits are used), 12345 (when 5 digits are used), and 123456 (when 6 digits are used) cannot be set as user codes.
- Do not set simple codes, such as 1111.
- * The same code cannot be set for both the user code and the master code. The previously set code has priority.**

Input the master code twice.
 (Default : 1 2 3 4 1 2 3 4)



IV Setting the key illumination time (Default: 10 Sec.) | V Setting the relay output time (Default: 3 Sec.) | VI Reset Settings | VII External output setting (Default: OFF)

When setting relay 1 When setting relay 2

Input the setting code. (A 0) Input the setting code. (A 1) Input the setting code. (A 2) Input the setting code. (A 5) Input the setting code. (A 6)

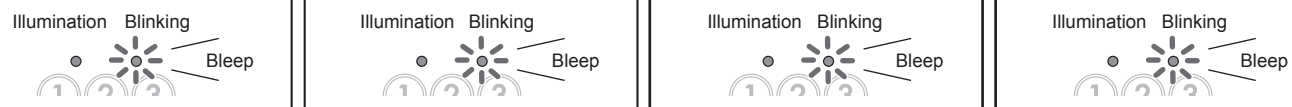

Inputting of illumination time (ex.: 20 seconds) 2 0 Inputting of relay output time (ex.: 99 seconds) 9 9

Indicator is lit up at all times: 00 Latched (※) : 00

1 2 3 1 2 3 0

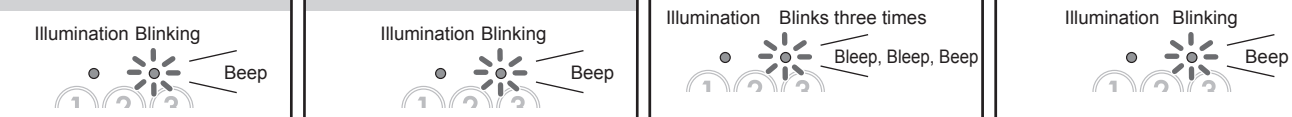

During Lockout During forced entry output During lockout and forced entry output OFF

- When the (B) key is pressed, the green LED lights up, the buzzer beeps twice, and the system exits the setting mode. (If the (B) key is included in the user code and the master code, the system does not exit the setting mode.)

- You can continue the setting up operation by entering an arbitrary setting code.

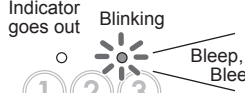

- (※) If the latched status has been set and the door is unlocked, it will not be locked again until the user code is entered (or the request to exit/entry button is pressed, or the (0) key is pressed while timer-linked unlocking is set).
- When the door is unlocked during relay outputting (including when latched), the system cannot be switched to the setting mode.
- If the power is turned off and the (1), (2), and (3) keys are pressed simultaneously while the unlock 1 input status is active (short circuit between terminals PB1 and C), the settings can be returned to their default values by turning the power back on and pressing the (1), (2), and (3) keys simultaneously for 3 seconds.
- When setting the external output, do not set the relay 2 output to be latched.

Input the master code twice.
(Default : 1 2 3 4 1 2 3 4)

(orange) Illumination (green) Blinking
Bleep, Bleep

VIII Lockout (Default: OFF)	IX Auto-relock (Anti-tailgate) (Default: OFF)	X Timer-linked unlocking setting (Default: relay 1, OFF)	XI Operation sound settings (Default: ON)
--------------------------------	---	---	--

Input the setting code. A 7	Input the setting code. A 8	Input the setting code. A 9	Input the setting code. A A
--------------------------------	--------------------------------	--------------------------------	--------------------------------

Illumination Blinking Bleep

OFF ON	OFF ON	Relays 1 and 2 are both linked Only relay 1 is linked Only relay 2 is linked	Operation tone OFF Operation tone ON
0 1	0 1	0 1 2	0 1

Illumination Blinking Bleep

Inputting the number of operations
(ex. : 10 times)
10 - 99 1 0

Illumination Blinking Bleep

Inputting length of time in "Lockout" mode
(Ex.: 10 seconds)
10 - 99 1 0

Illumination Blinking Bleep

0 key illumination OFF while timer is on 0 key illumination ON while timer is on

0 1

Illumination Blinking Bleep

- When the **B** key is pressed, the green LED lights up, the buzzer beeps twice, and the system exits the setting mode.
(If the **B** key is included in the user code and the master code, the system does not exit the setting mode.)

- You can continue the setting up operation by entering an arbitrary setting code.

Indicator goes out Blinking Bleep, Bleep

- When the relay 1 output time is set to latched output, the auto-relock function is disabled.
- When the auto-relock function is turned on, the unlock function of the request to exit/entry button of relay 2 is disabled.
- If the 0 key illumination function is turned on while the timer is on, only the 0 key illumination will light up, even if the "key illumination time setting" is set to "Indicator is continually lit".

OPERATION OF ACCESS CONTROL

- * Also refer to the "INSTALLATION & OPERATION MANUAL" for the master station (JK-1MED or JK-1MD) connected to this unit regarding the operation of the video door station.

A. Unlocking of user code

When the registered user code has been input using the keypad (between 4 and 6 digits), the LED indicator (group 1: orange, group 2: green) lights up, the buzzer sounds, and the electric door strike is unlocked.

ex.) group 1
1006

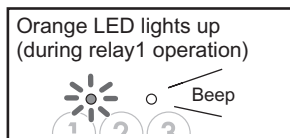

group 2
04B2

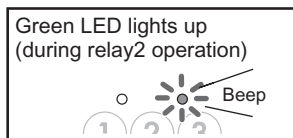

- The time interval during which the button must be pressed is approximately 10 seconds. If the time interval exceeds approximately 10 seconds, the input value will be cleared.
- If you make a mistake when inputting the user code, input the user code again.

- When the "Lockout" function has been set, the release function is locked and the input operation is disabled for the specified time (10 - 99 seconds) if invalid codes are input a set number of times (10 - 99 times). (Reference: "Lockout".) During this time, the key illumination will blink 4 times, the LED (orange) indicator will blink for the set deactivation time, and the buzzer will sound for approximately 3 seconds.

B. Timer-linked unlocking

When the timer-linked unlocking function is active, the door can be unlocked by pressing the key during the set time, while the timer is linked.

The key illumination lights up when the timer is activated by performing the setting.

C. Unlocking using the request to exit/entry button

When leaving the premises, you can activate the electric door strike by pressing the request to exit/entry button connected to the unit. Pressing request to exit/entry button 1 releases relay 1, and pressing request to exit/entry button 2 releases relay 2.

- When the door is unlocked using the request to exit/entry button, the LED will not light up and the buzzer will not sound.

TECHNICAL PRECAUTIONS

- Operating temperature: Between -10°C and 60°C (+14°F to 140°F)
- Cleaning: Clean the unit with a soft cloth dampened with a neutral household cleanser. Do not use any abrasive cleanser or cloths.
- The unit is weather resistant. However do not spray high pressure water on the unit directly. Excessive moisture may cause problems with the unit.
- Press and release the , , , and keys simultaneously when the Access control does not work.
 - * The LEDs (orange and green) will blink and the buzzer will sound, and then resetting will take place. (The settings do not return to their default values.)
- If resetting does not work, contact the service technician who installed the unit.

SPECIFICATIONS

General

- Dimensions:
Door station: 295(H) × 144(W) × 8(D) (recess: 30) mm
H 11-5/8" x W 5-3/4" x D 5/16", recess 1-3/16"
Flush mount back box: 263(H) × 114(W) × 45(D) mm
H 10-3/8" x W 4-1/2" x D 1-3/4"
- Weight:
Door station: approx. 890g (1.97 lbs)
Flush mount back box: approx. 600g (1.3 lbs)

Video door station

- Power supply: Supplied from the master station
- Camera unit: Complementary metal oxide semiconductor (CMOS)
- Scanning lines: 525 lines
- Minimum subject illumination: 5 Lux at 50 cm (1' 6") distance

Access control keypad

- Power supply: 12 - 24V AC
12 - 24V DC
- Power consumption: DC: Max. 70mA
AC: Max. 100mA
- Number of relay circuits: 2
- Relay contact: N/O, N/C
- Relay contact capacity: 24V DC, 3A (resistive load)
1A (inductive load)
24V AC, 3A (resistive load)
1A (inductive load)

WARRANTY

Aiphone warrants its products to be free from defects of material and workmanship under normal use and service for a period of two years after delivery to the ultimate user and will repair free of charge or replace at no charge, should it become defective upon which examination shall disclose to be defective and under warranty. Aiphone reserves unto itself the sole right to make the final decision whether there is a defect in materials and/or workmanship; and whether or not the product is within the warranty. This warranty shall not apply to any Aiphone product which has been subject to misuse, neglect, accident, or to use in violation of instructions furnished, nor extended to units which have been repaired or altered outside of the factory. This warranty does not cover batteries or damage caused by batteries used in connection with the unit. This warranty covers bench repairs only, and any repairs must be made at the shop or place designated in writing by Aiphone. Aiphone will not be responsible for any costs incurred involving on site service calls. Aiphone will not provide compensation for any loss or damage incurred by the breakdown or malfunction of its products during use, or for any consequent inconvenience or losses that may result.

FCC

This device complies with Part 15 of the FCC Rules. Operation is subject to the following two conditions: (1) this device may not cause harmful interference, and (2) this device must accept any interference received, including interference that may cause undesired operation.

