

CLIPSAL[®]

by Schneider Electric

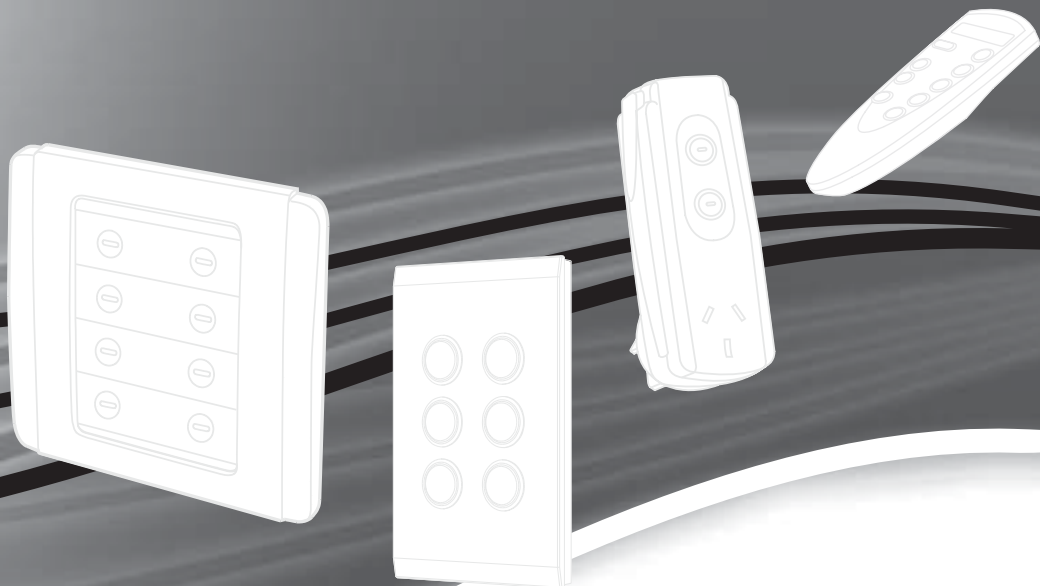

C-Bus[®]

Wireless Series (433.92MHz)
x585x, x588x, 5812,
5888TXBA Series



Installation Instructions

Contents

| | | |
|-------------|---|-----------|
| 1.0 | Product Range | 3 |
| 2.0 | Important Notes | 3 |
| 3.0 | Description | 3 |
| 4.0 | Definitions | 5 |
| 5.0 | Basic Operation | 6 |
| 6.0 | C-Bus Wireless Networks..... | 7 |
| 6.1 | Creating a Network..... | 7 |
| 7.0 | Grouping Buttons Together | 8 |
| 7.1 | Using Timers..... | 10 |
| 8.0 | The Remote Control | 11 |
| 8.1 | Installing the Batteries | 12 |
| 8.2 | Programming the Remote..... | 12 |
| 8.3 | Clearing Remote Assignments | 14 |
| 9.0 | Scenes | 15 |
| 9.1 | Creating a Scene Button..... | 15 |
| 9.2 | Learning a Scene | 16 |
| 10.0 | Factory Resets | 17 |
| 10.1 | Button Reset..... | 17 |
| 10.2 | Unit Reset | 18 |
| 11.0 | Care Instructions | 19 |
| 11.1 | Removing the Saturn Fascia..... | 19 |
| 12.0 | Power Failure | 20 |
| 13.0 | Limitations..... | 20 |
| 14.0 | Learn Mode Programming Examples | 20 |
| 14.1 | Networking Units Together..... | 20 |
| 14.2 | Grouping Three Buttons Together..... | 21 |
| 14.3 | Grouping Buttons with a Timer | 21 |
| 14.4 | Assigning a Remote Control Button..... | 22 |
| 14.5 | Clearing a Unit's Remote Assignments | 22 |
| 14.6 | Button Reset..... | 22 |
| 14.7 | Unit Reset..... | 23 |
| 14.8 | Creating a Scene Button..... | 23 |
| 14.9 | Learning a Scene | 24 |
| 15.0 | Troubleshooting..... | 24 |
| 16.0 | Electrical Specifications | 26 |
| 17.0 | Mechanical Specifications | 29 |
| 18.0 | Warranty | 30 |
| 19.0 | Warranty Statement..... | 31 |
| 20.0 | Technical Support and Troubleshooting..... | 32 |

1.0 Product Range

This manual applies to the units listed below.

| Catalogue Number | Description |
|------------------|---|
| 585xAA Series | C-Bus Wireless Neo™ Wall Switch Series |
| E585xAA Series | C-Bus Wireless Neo™ Wall Switch Series (square fascia) |
| 588xAA Series | C-Bus Wireless Saturn™ Wall Switch Series |
| E588xAA Series | C-Bus Wireless Saturn™ Wall Switch Series (square fascia) |
| 5812D3L1AA | C-Bus® Wireless Plug Adaptor (leading edge dimmer) |
| 5812D2T1AA | C-Bus® Wireless Plug Adaptor (trailing edge dimmer) |
| 5812R10F1AA | C-Bus® Wireless Plug Adaptor (relay) |
| 5888TXBA | C-Bus® Wireless Remote Control |

2.0 Important Notes

- C-Bus Wireless wall switches must be installed by appropriately qualified personnel.
- Wall switches must be connected to circuits that incorporate 10A rated circuit breaker protection.
- All two channel wall switch relay units require both channels to have loads connected for proper operation.
- Some load types such as most compact fluorescent lamps (CFLs also known as energy saver lamps), are incompatible with dimmers and electronic switches. Do not use these with C-Bus Wireless wall switch relay units (unless specially modified by your installer), or C-Bus Wireless dimmer units.
- When using fluorescent lamps with C-Bus Wireless wall switch relay units, ensure they meet the unit's minimum load rating (25W).

WARNING

No isolation is provided by wall switches. Hazardous voltage exists at the load terminals and lamp sockets in the unit's "off" state. Ensure that the circuit breaker is switched off before changing light bulbs, etc.

3.0 Description

C-Bus Wireless wall switches are a two-wire retrofit range of C-Bus radio frequency (RF) devices, designed to replace standard wall switches and dimmers. C-Bus Wireless wall switches and plug adapters can be operated by remote control, and have learn and scene capability.

The learn capability allows you to link multiple units into a common network. You can create associations between buttons on multiple units, so that a button press on one unit will operate a button on another (activating connected lights or other appliances). C-Bus Wireless learn is used to:

- link the remote control to a wall switch or plug adaptor
- link wall switches and plug adaptors into a network.

Scene capability allows you to perform a series of actions across multiple units by pressing a single button. For example, on arrival home you could use a scene to switch on lights in the hallway and kitchen, dim lights in the lounge, and switch on a heater.

The following illustrations show possible C-Bus Wireless unit installations. The room in Figure 1 uses stand-alone units, which can be operated by remote control. The room in Figure 2 uses networked units where buttons on one unit can operate other units or trigger scenes.

This User's Guide describes how to program C-Bus Wireless units using learn mode. Step by step instructions are provided for common learn tasks.

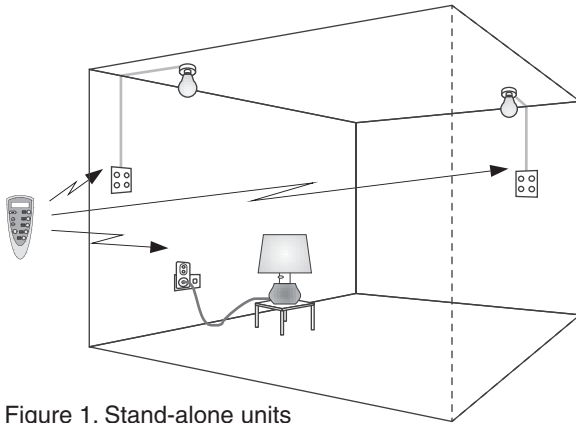

Figure 1. Stand-alone units switched by remote control

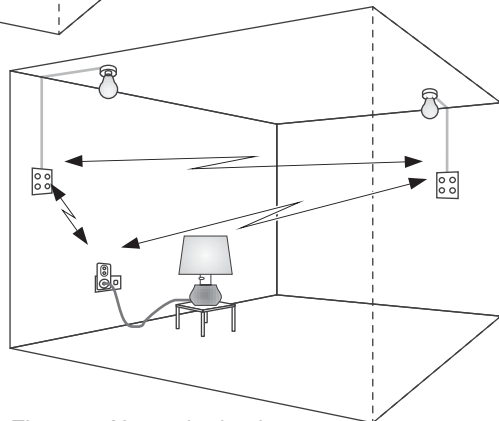

Figure 2. Networked units (buttons on one unit can operate other units)

4.0 Definitions

The definitions in Table 1 are used in discussing C-Bus Wireless units. Button types are shown in Figure 3.

| | |
|----------------------|--|
| load | A light or other electrical appliance connected to a C-Bus dimmer, relay or other output unit. Examples include lights, heaters and electric motors. |
| scene | A series of actions across multiple C-Bus units, triggered by a single button. For example, on arrival home you could use a scene to switch on lights in the hallway and kitchen, dim lights in the lounge, and switch on a heater. |
| local control button | A button on a C-Bus Wireless unit that is linked to an output channel of the same unit. Wireless C-Bus devices have one pair of local control buttons for each of their output channels (the topmost buttons). |
| free button | Any button on a C-Bus Wireless unit that is NOT a local control button. Plug adapters do not have any free buttons. |
| group | An association between buttons, and typically one or more loads. Allows the control of one load from multiple switches. |
| learn mode | <p>A configuration state of C-Bus Wireless. Learn mode enables you to create associations between buttons on units, and add functionality such as timers and remote control.</p> <p>Learn mode is entered by pressing and holding a local control button pair for 10 seconds (until the unit's indicator lights start flashing alternately). Once in learn mode, the local control button indicators of all units in the same network continue to flash alternately, except for buttons which are grouped to the local control button pair from which you entered learn mode.</p> <p>Note that learn mode may be disabled by special software.</p> |
| quick-press | A brief button press (pressed for a fraction of a second). |
| double quick-press | Two quick-presses in quick succession. |

Table 1. Definitions

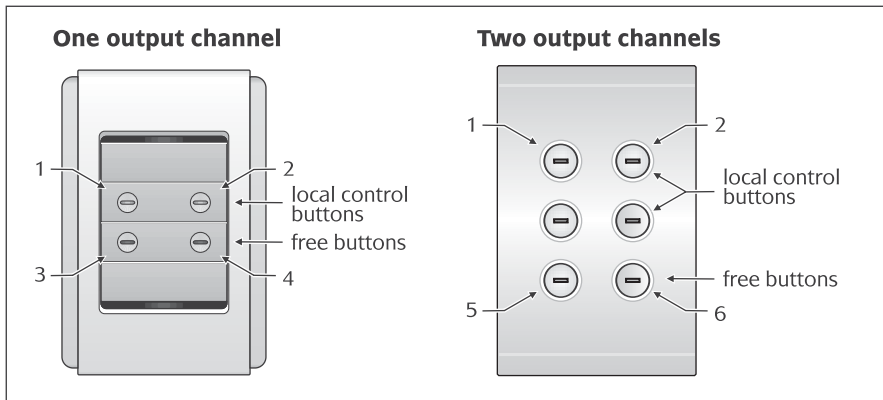

Figure 3. Neo (left) and Saturn (right) C-Bus Wireless wall switch dimmer unit

5.0 Basic Operation

When a C-Bus Wireless wall switch or plug adapter is first installed, it functions as a stand-alone unit. In this default mode, the unit functions as a dimmer or switch. The advantages of wireless operation are not utilised.

C-Bus Wireless plug adapters have one output channel (a single AC mains socket) and two buttons. Wall switches are available in one or two output channel versions, with two, four, six or eight buttons (depending on the style). Each channel controls one or more lights or other appliances connected to its output.

Buttons on a C-Bus Wireless wall switch or plug adapter are organised in pairs that control the output channels, (local control buttons). Remaining buttons (free buttons) are used to control outputs on other units when multiple C-Bus Wireless units are configured as part of a network.

For example, Figure 3 shows a 6 button, 2 channel Saturn C-Bus Wireless wall switch dimmer unit. Its buttons perform the following functions:

- Buttons 1 and 2 control the first channel,
 - A quick-press on either button toggles the channel on or off. A long press on either button dims the unit in alternate directions.
 - If the channel is set to an intermediate dim level, button 1 commences with dim down, and button 2 commences with dim up. (When a channel has not been adjusted for 15 seconds or more, the highest numbered button always gives preference to dim up).
- Buttons 3 and 4 control the second channel in the same way as buttons 1 and 2 control the first.
- Buttons 5 and 6 are unused when the unit is used as a stand-alone unit. They may be used to control outputs on other units when part of a multi-unit network.

6.0 C-Bus Wireless Networks

To experience the full capabilities of wireless operation, C-Bus Wireless units must be linked together to form a network.

To communicate with each other successfully, units within the same network must be located no further than 20 metres from each other (Figure 4). This range will vary depending on the building's construction and the proximity to dense or metallic objects. Refer to the Typical Range specified on Page 26.

A network may consist of dozens of units. For best results however, it is recommended that no more than 30 units be placed within the same network. You may have multiple networks within the same building. As a general rule, units in one network cannot control units in another (there are exceptions to this when using special hardware and software).

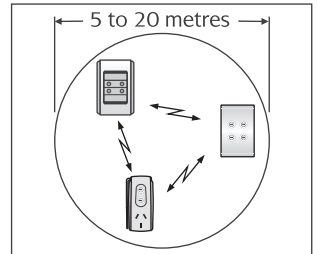

Figure 4. Network range

6.1 Creating a Network

When a C-Bus Wireless wall switch or plug adapter is first installed, it operates as a stand-alone unit. Before it can communicate with other units, it must be configured to be part of a C-Bus Wireless network.

To create a network of units:

- 1) **Select a unit to be networked to.**
(If all units are new, this can be any unit. If you are adding a new unit to an existing network, this must be a unit on your existing network).
- 2) **Press and hold the top two buttons for 10 seconds (until the unit's indicator lights start flashing alternately and rapidly). This activates learn mode.** Only the local control button indicators flash. This flashing slows down after 5 seconds. At this time, if the buttons are part of a group, they will remain lit and no longer flash.
- 3) On each unit you are adding to the network, **perform step b) within 5 seconds of completing step a).**
 - a) **Press and hold the top two buttons for 10 seconds** (activate learn mode as you did for the unit in step 2).
 - b) **While the indicators are flashing quickly, press and hold the top two buttons again*, for 2 seconds.** The indicator lights start flashing simultaneously.

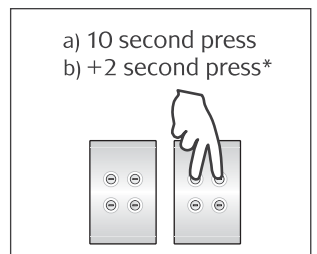
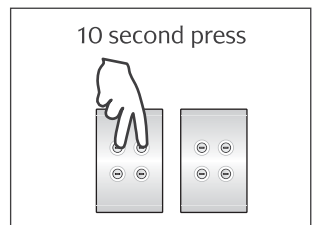
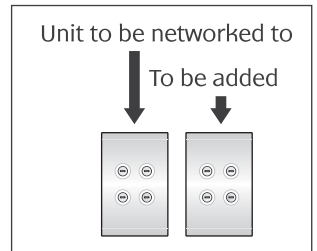

*If you do not perform step b) within 5 seconds of step a) (before the alternate flashing slows down), pressing the top two buttons together will exit learn mode.

4) **Go back to the unit to be networked to. Hold down the left topmost button and, while continuing to hold, quickly double-press the right topmost button.** This links the units you selected in step 3) into the same network as this unit.

5) **Check the units added to the network.** They will return to learn mode (where they will flash alternately) after flashing quickly for several seconds.

If the indicators of a unit continue to flash slowly and simultaneously, the unit has not been added to the network (probably due to radio frequency (RF) interference or the unit being out of range). Try repeating step 4 on the unit to be networked to.

6) After networking the units together, they remain in learn mode ready for further learn activities (such as grouping buttons together, explained in the next chapter).

7) **To exit learn mode and return the units to normal switch or dimmer operation, press and hold the top two buttons for 1 second.**

Your units are now part of a C-Bus Wireless network.

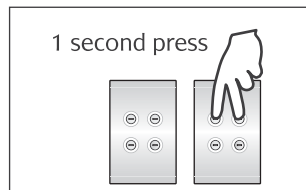
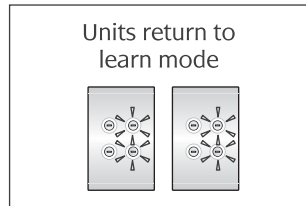
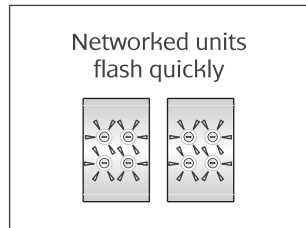
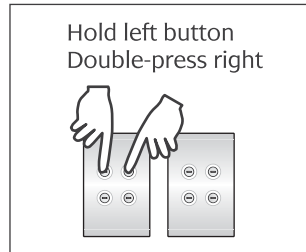

7.0 Grouping Buttons Together

When C-Bus Wireless units are linked together in a network, you can associate buttons on one wall switch or plug adapter, with buttons on other units. This is called grouping buttons.

Before you group buttons together, there are some rules you should be aware of:

- You must enter learn mode from the local control buttons you want to include in a group.
- You cannot group a free button to a local control button on the same wall switch (see Page 5 for definitions).

- After grouping one free button on a wall switch with a local control button on another unit, the free button,
 - toggles on/off for quick-presses
 - dims up/down for long presses (on dimmer units).
- After grouping two free buttons on a wall switch with a local control button on another unit,
 - both free buttons toggle on/off for quick-presses
 - either button dims the unit in alternate directions for long presses. If the channel is set to an intermediate dim level, the highest numbered button commences with dim up, and the other commences with dim down. (When a channel has not been adjusted for 15 seconds or more, the highest numbered button always gives preference to dim up).
- Up to two free buttons per wall switch can be included in any group.

To group buttons together:

- 1) **Go to a unit that has a local control button pair you want to group with one or more other buttons. Press and hold the pair for 10 seconds, to activate learn mode.** The indicator lights on all units in the same network will flash alternately.

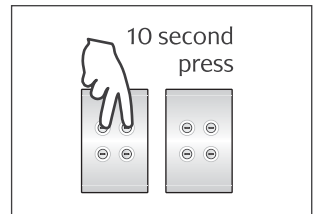

After 5 seconds, if the pair is already part of a group, all buttons belonging to the group will be selected (their indicators and loads will switch on).

- 2) **Press the buttons on the units you want to add to the group. Use quick presses.** The indicator of each selected button will remain lit. To remove a button from the group, simply press to deselect it.

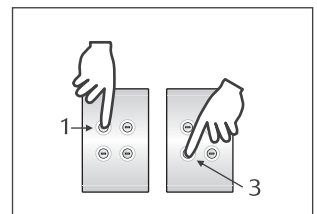

Note that local control buttons work in pairs (pressing either local control button will select or deselect both).

- 3) **When you have selected all the buttons you want in a group, press and hold the top two buttons of any unit in the network for 1 second, to exit learn mode.**

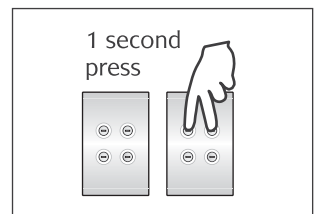

In the illustrations above, button 1 of the unit on the left is grouped with button 3 of the unit on the right. This means that pressing button 3 of the right unit will activate buttons 1 and 2 of the left unit, which operate as a pair. (A light or other appliance connected to button 1's channel output can be operated from button 3 of the other unit).

7.1 Using Timers

When using learn mode to add buttons to a group, you can set a button to work as a timer. You do this by holding the button down instead of using a quick-press (as in step 3 below). After about 1 second, the indicator light double-flashes, signifying that the button has been set as a timer. As you continue to hold the button, the indicator continues to double-flash. The timer is incremented by 5 minutes for each double-flash.

To group buttons together and make one a timer:

- 1) **Go to a unit which has the local control button pair you want to group with a timer button. Press and hold the button pair for 10 seconds, to activate learn mode.** The indicator lights on all units in the same network will flash alternately.

After 5 seconds, if the pair is already part of a group, all buttons belonging to the group will be selected (their indicators will remain lit).

- 2) **Press the buttons you want to add to the group. Use quick-presses.**
- 3) **Press and hold the button you want to use as a timer. Ensure you can see the button's indicator.** Count the double-flashes, and release the button once the count corresponds with the timer period you want (one double-flash for each 5 minutes).
- 4) **Press and hold the top two buttons of any unit in the network for 1 second, to exit learn mode.**

In the illustrations above, button 3 of the unit on the right is set as a timer for button 1 of the unit on the left. Step 3 is where the button is set as a timer. If the button is held for 4 seconds, the indicator light will double-flash after 1 second, and again after each of the following 3 seconds. The timer period will be set for 20 minutes (4 × 5 minutes).

You can select either a single button or a pair of buttons on the same wall switch or plug adapter, to function as a timer (local control buttons work in pairs):

- A single button timer will switch a light (or other appliance) on, and automatically switch it off after the timer period.
- When a pair of buttons work as a timer, the highest numbered button will switch the light on with a timer. The other button will switch it on or off with no timer.

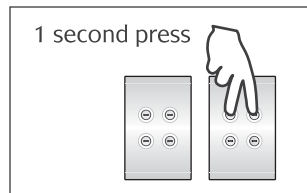
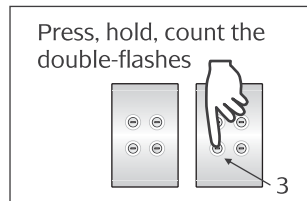
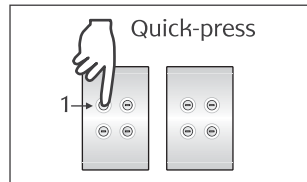
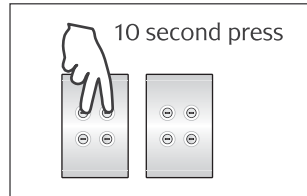

To group buttons together with a timer button pair:

- 1) **Go to a unit which has a local control button pair you want to group with a timer button. Press and hold the button pair for 10 seconds, to activate learn mode.**

The indicator lights on all units in the same network will flash alternately.

After 5 seconds, if the pair is already part of a group, all buttons belonging to the group will be selected (their indicators will remain lit).

- 2) **Quick-press the buttons you want to add to the group. Quick-press the first free button you want to use as a timer.**
- 3) **Hold down the second free button you want to use as a timer (on the same unit). Ensure you can see the button's indicator. Count the double-flashes, and release the button once the count corresponds with the timer period you want (one double-flash for each 5 minutes).**
- 4) **Press and hold the top two buttons of any unit in the network for 1 second, to exit learn mode.**

In the illustrations above, buttons 3 and 4 of the unit on the right will work as a timer pair for button 1 of the unit on the left. Button 4 will switch button 1 on with the timer (to switch off after the timer period expires). Button 3 will switch button 1 on or off with no timer.

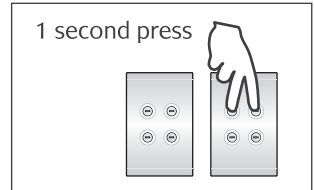
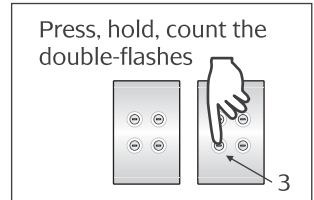
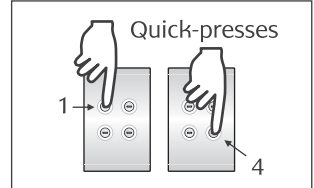
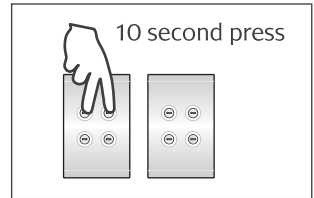

8.0 The Remote Control

The C-Bus Wireless Remote Control allows you to control buttons on C-Bus Wireless wall switches and plug adapters. It is a radio frequency (RF) remote that works up to 15 to 20 metres from a device it controls. Unlike an infrared (IR) remote, you do not need to point it at the unit you want to control.

Up to 10 separate buttons on wall switches or plug adapters can be controlled by the remote control unit. These can be on various units on different networks. A single button on a wall switch or plug adapter can be controlled by up to two remote controls.

Shift key alternates between banks

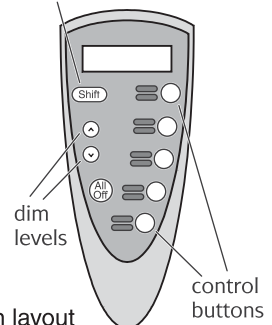

Figure 5 – Button layout

Remote buttons are organised in two banks of five. Banks are alternately selected by pressing the Shift button (Figure 5).

Up and Down buttons allow you to dim the level associated with the last button selected (on dimmer units). An All Off button provides a convenient way to switch off every light or other appliance that has been associated with the remote control.

8.1 Installing the Batteries

The C-Bus Wireless Remote Control uses 2 × AAA batteries. Alkaline batteries are recommended. To install the batteries:

- 1) Turn the remote upside down.
- 2) Press the tab and slide the back cover down to release (refer to Figure 6).
- 3) Insert the batteries. Ensure the + and - terminals match the symbols inside the battery compartment.
- 4) Replace the back cover (position and slide up).

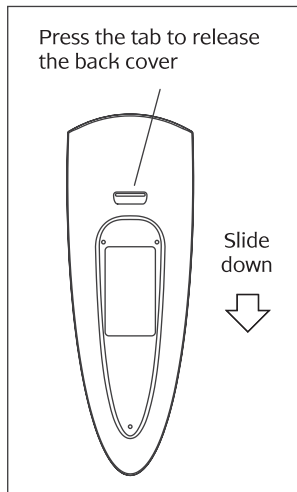

Figure 6 – Removing the back cover

8.2 Programming the Remote

Before the Wireless Remote Control can be used, C-Bus Wireless units must be programmed to recognise the remote's buttons. The remote, wall switch and plug adapter units do this in learn mode.

Learn mode is activated on the remote by removing the back cover (as when installing batteries), and sliding the switch across to the Learn position. The remote's learn mode switch is shown in Figure 7.

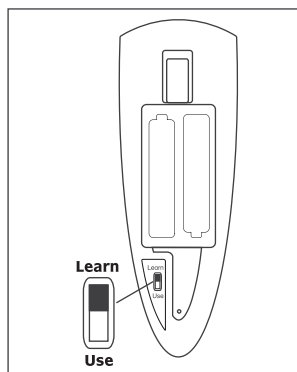
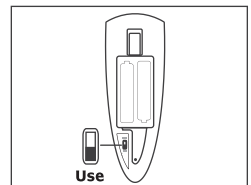
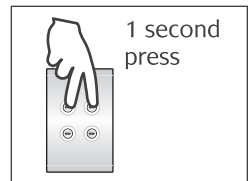
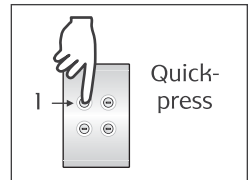
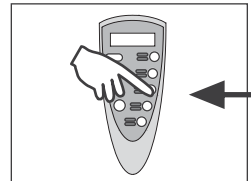
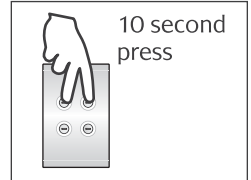
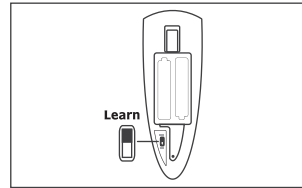

Figure 7 – Activating the remote's learn mode

The following procedure is used to assign a button on the remote to a button on a C-Bus Wireless wall switch or plug adapter:

- 1) **Set the C-Bus Wireless Remote Control to learn mode, as described on the previous page** (slide the switch across to the Learn position).
- 2) **On the wall switch or plug adapter, press and hold the top two buttons for 10 seconds, to activate learn mode.** (The indicator lights on all units in the same network will flash alternately).
- 3) **On the remote, press and release the button you want to assign.** (The indicators on all wall switches and plug adapters in the same network will flash simultaneously).
- 4) **On the wall switch or plug adapter, quick-press the button you want the remote to control.** Do this within 30 seconds of pressing the remote button in the step above (while the indicators are flashing).
- 5) **Repeat steps 3 and 4 for any additional remote buttons you want to assign.**
- 6) **When you have finished programming remote buttons, press and hold the top two buttons of any unit in the network for 1 second, to exit learn mode.**
- 7) **Slide the learn mode switch on the remote back to the Use position.**



In the illustrations above, the third assignable remote button is assigned to button 1 of the wall switch. This means that a light operated from button 1 of the wall switch can also be operated from button 3 of the remote.

Note: Assigning a button on the remote to a button on a C-Bus Wireless unit does not unlearn any previous assignments to other units. To do this you need to clear the previous remote assignments (section 8.3).

8.3 Clearing Remote Assignments

You can clear an individual remote assignment learned by a specific button on a wall switch or plug adapter. You do this by re-assigning the remote button to the wall switch or plug adapter button, (assigning a button once learns it, assigning it again clears it).

You can clear all remote assignments (from all remote controls) learned by an individual wall switch or plug adapter. To do this:

- 1) Set the C-Bus Wireless Remote Control to learn mode, as described on page 12 (slide the switch across to the Learn position).

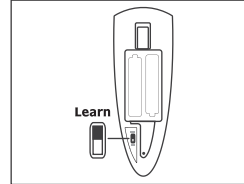

- 2) On the wall switch or plug adapter, press and hold the top two buttons for 10 seconds, to activate learn mode.

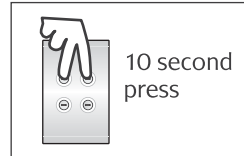

- 3) Press and release any one of the five assignable buttons on the right side of the remote control.

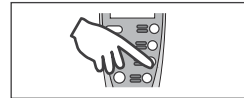

- 4) Double quick-press one of the buttons on the wall switch or plug adapter.

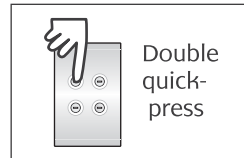

- 5) Wait until the indicator lights return to a slow alternating flash. Then press and hold the top two buttons on the wall switch or plug adapter for 1 second, to exit learn mode.

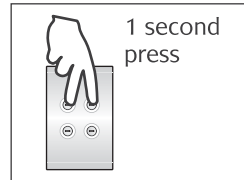

- 6) Slide the learn mode switch on the remote control back to the Use position.

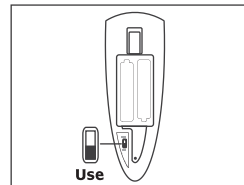

9.0 Scenes

A scene allows you to perform a series of actions across multiple C-Bus units with the press of one button. For example, on arrival home you could use a scene to switch on lights in the hallway and kitchen, dim lights in the lounge, and switch on a heater.

A unit can have as many scenes as it has buttons, depending on how many groups of buttons the scenes control. The total number of button groups that scenes in a unit may control is between 46 and 49, depending on organisation. For example, a unit may contain one scene which controls 49 button groups, or three which control 16 button groups each.

There are two stages of creating a scene:

- 1) You must create a scene button. This is a button that will be used to trigger the scene. Any button can be used as a scene button (it is normally best to use a free button).
- 2) You must learn the scene. This involves setting the states or levels of lights or other appliances you want to be recalled (by pressing grouped buttons), and assigning these to the scene button.

Note: that before a button can be included in a scene, it must be grouped to another button (as in Section 7.0), or at least to itself (if it is a local control button).

To group a local control button to itself:

- 1) Enter learn mode from the local control button pair.
- 2) Select the local control button (its indicator will illuminate).
- 3) Exit learn mode.

9.1 Creating a Scene Button

A scene button is created by double quick-pressing a button in learn mode:

- 1) Go to the unit on which you want to create a scene button. Press and hold the top two buttons for 10 seconds, to activate learn mode.
- 2) Double quick-press the button you want to set as a scene button (it will begin flashing quickly).
- 3) Press and hold the top two buttons for 1 second, to exit learn mode.

In the illustrations to the right, button 3 is set as a scene button. It can then be used to learn a scene (as described in the following section).

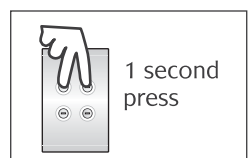
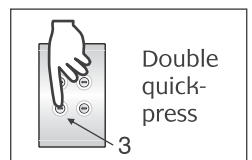
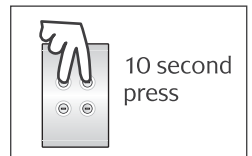

9.2 Learning a Scene

Once a scene button has been created, you can use it to capture the states or levels of lights and other appliances within the same network (by pressing grouped buttons). These states can then be recalled by pressing the scene button. (You can group an ungrouped local control button to itself, so it can be included in a scene. To do this, enter learn mode from the local control button pair, select the local control button and exit learn mode.)

To capture the states of other buttons (learn a scene):

- 1) Press and hold the scene button for 10 seconds (until it starts flashing).

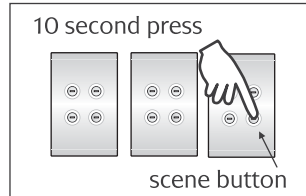

- 2) Use grouped buttons on any units within the same network, to set the states of the lighting levels and other electrical appliances that you want to capture as part of the scene. You can switch buttons on, or set them to a specific level (in the case of dimmers). To capture an off state, switch a button on and then off.

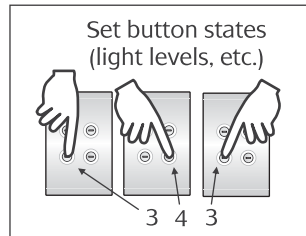

- 3) Press and hold the scene button for 1 second (until it stops flashing), to exit scene learn mode.

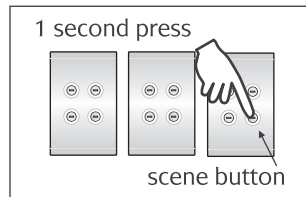

In the illustrations to the right, three button states are captured and stored in a scene. Each state may consist of on, off or a particular lighting level (depending on what appliance is connected, and whether the unit is a relay or dimmer). Buttons 3, 4 and 3 of the first, second and third respective units, are added to the scene button in the third unit.

10.0 Factory Resets

10.1 Button Reset

The button reset allows you to clear a button on a C-Bus Wireless wall switch or plug adapter to its original factory default state. This allows you to:

- delete a scene button
- remove any special button programming made by software.

To reset a button back to its factory default state:

- 1) Press and hold the top two buttons for 10 seconds, to activate learn mode. (The indicator lights will flash alternately).

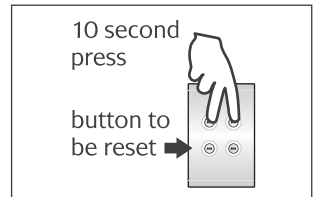

- 2) Double quick-press any button on the unit.

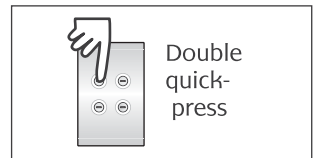

- 3) Double quick-press the same button again.

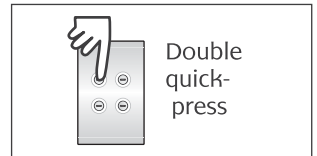

- 4) Press and hold the button you want to reset for 2 seconds (until the indicator flashing slows down).



- 5) Press and hold the top two buttons for 1 second to exit learn mode.

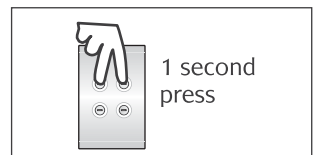

10.2 Unit Reset

The unit reset allows you to clear a C-Bus Wireless wall switch or plug adapter to its original factory default settings. This is recommended under the following circumstances:

- when adding a previously programmed unit to a new network (perhaps changing from a single to multiple network installation)
- if you lose track of where you are up to when programming a unit.

To reset a unit back to its factory default settings:

- 1) Press and hold the top two buttons for 10 seconds, to activate learn mode. (The indicator lights will flash alternately).

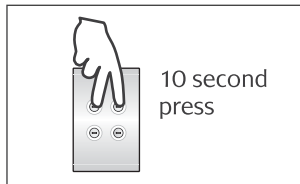

- 2) Double quick-press any button on the unit.

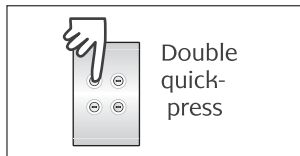

- 3) Double quick-press the same button again.

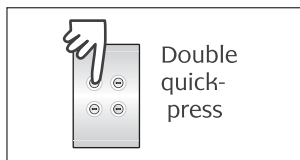

- 4) Press and hold the top two buttons for 1 second (until the indicators stop flashing).



- 5) The unit being reset will perform a series of flashes for about 10 seconds, before returning to the standard learn mode slow alternating flash.

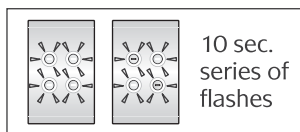

- 6) Press and hold the top two buttons again for 1 second to exit learn mode.



11.0 Care Instructions

C-Bus Wireless units contain electrical and electronic parts to support their functions. Be sure to note the following precautions.

- Clean regularly using a soft lint free cloth.
- Do not use chemicals or spray cleaners when cleaning.
- Do not operate with wet hands.
- Do not use hard, sharp objects to select the controls.
- Allow adequate ventilation. Do not cover the unit.
- C-Bus Wireless units are designed for indoor use only.
- Do not expose to direct sunlight for extended periods.

11.1 Removing the Saturn Fascia

The Saturn fascia is removable. This means you can replace the fascia with a different style or colour, or temporarily remove it to paint the wall.

'A' Series Saturn Fascia

To remove an 'A' Series Saturn fascia:

- 1) Use a small flat head screwdriver to push the release locks inward, to disengage the clips. Release locks are located at the base of 'A' Series units.
- 2) Swing the lower end of the fascia about 5 mm away from the grid, until it is free.
- 3) Push the fascia upward and pull gently to release the upper clips.

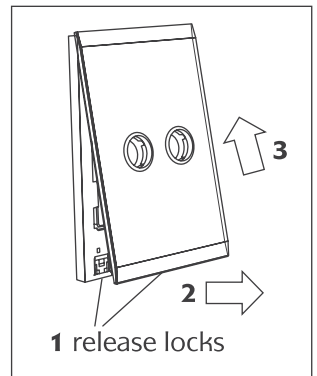

'E' Series Saturn Fascia

To remove an 'E' Series Saturn fascia:

- 1) Use a small flat head screwdriver to push the four release locks inward, to disengage the clips. Release locks are located on both sides of 'E' Series units.
- 2) Gently pull the fascia off the grid plate.

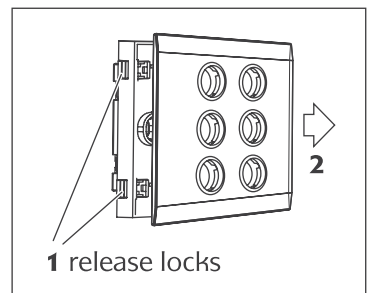

12.0 Power Failure

All C-Bus units have on-board non-volatile memory, which is used to store the operating state in case of mains power loss. After a power failure, the on/off and dimmer level states of wall switches and plug adapters, are restored according to the states before the power failure. Restoration occurs approximately 10 to 20 seconds after power resumes.

13.0 Limitations

- C-Bus Wireless relay units may sometimes switch the indicators off momentarily. This usually occurs when a load has been switched off, and is normal behaviour.
- Wireless wall switches include a thermal overload protection mechanism. If excessive load is connected to a C-Bus Wireless unit, dimmers will dim down and relay units will not operate. If this condition is observed, the load on the unit should be reduced. Relays will not resume functionality until mains power has been switched off and on.
- It is recommended that no more than 30 units be placed in a single network.
- This equipment uses radio communication for its operation. Communication between units requires a clear radio path. Some types of installation and building materials can severely disrupt radio communication. The range quoted is typical and not guaranteed. The range will be severely reduced if this equipment is placed inside metal enclosures.

14.0 Learn Mode Programming Examples

14.1 Networking Units Together

To link a plug adapter and a wall switch to another wall switch:

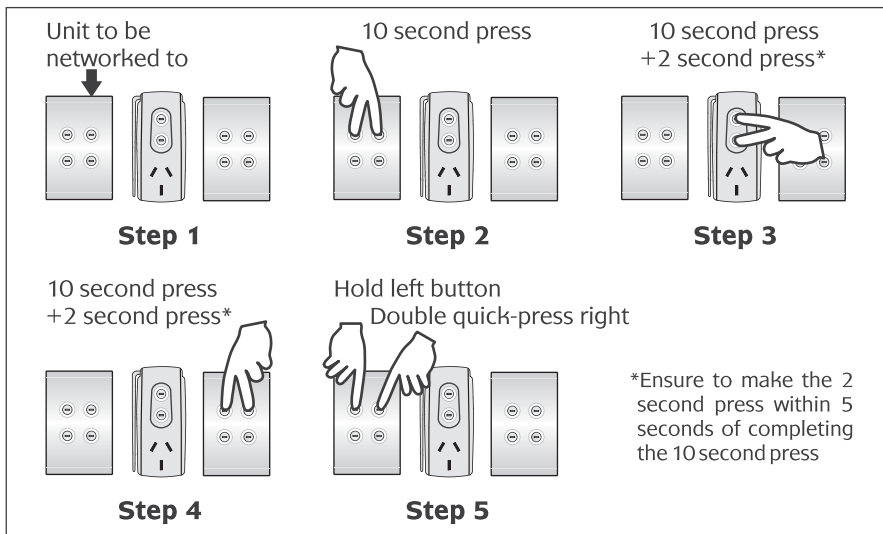

14.2 Grouping Three Buttons Together

To group buttons on three networked units:

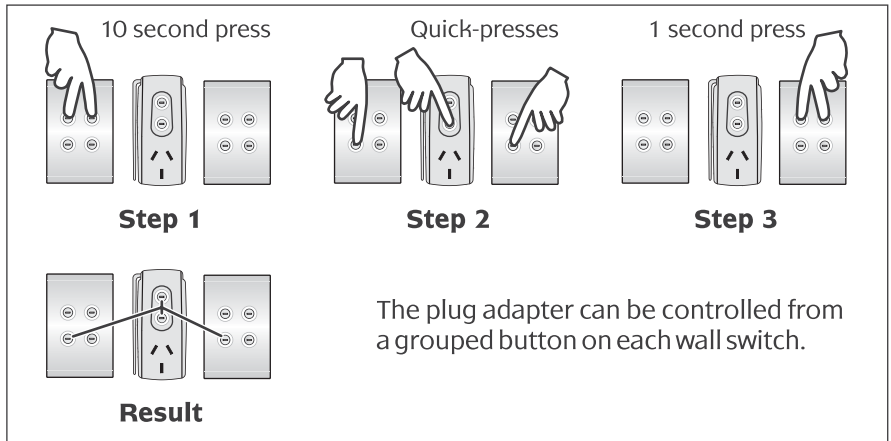

14.3 Grouping Buttons with a Timer

To group a 30-minute single button timer to a button on a networked unit:

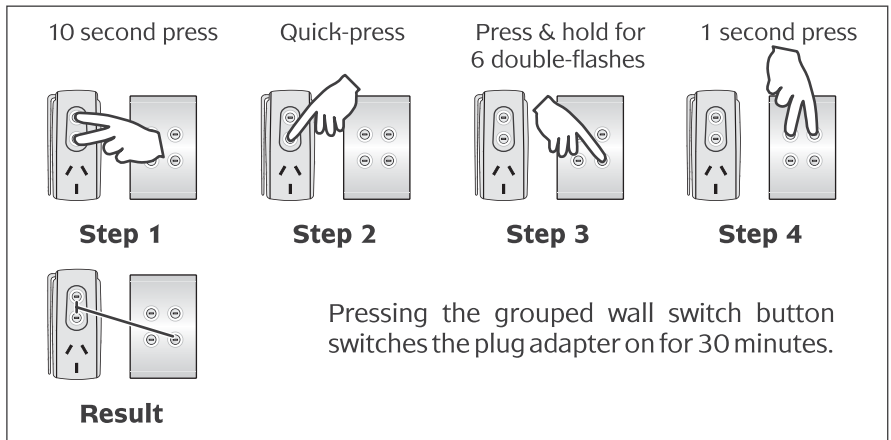

14.4 Assigning a Remote Control Button

To assign a remote control button to a button on a unit:

Step 1 **Step 2** **Step 3** **Step 4** **Step 5** **Step 6**

Result

The plug adapter can be controlled from the remote control button. Quick-presses on the remote, switch the plug adapter on and off. If the plug adapter is a dimmer, long presses on the remote dim it up and down.

14.5 Clearing a Unit's Remote Assignments

To delete all the remote control button assignments in a unit:

Step 1 **Step 2** **Step 3** **Step 4** **Step 5** **Step 6**

14.6 Button Reset

To clear a button to its original factory default state:

Step 1 **Step 2** **Step 3** **Step 4**

14.7 Unit Reset

To reset a unit back to its original factory default settings:

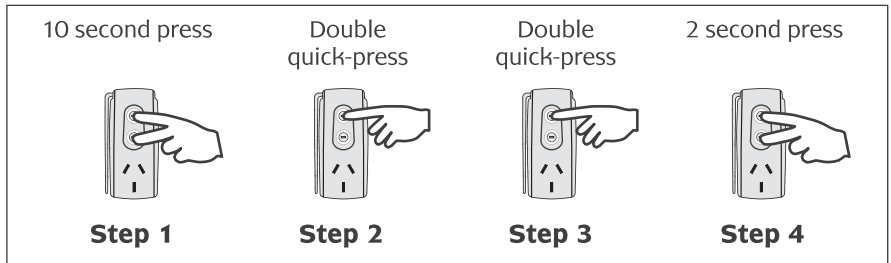

14.8 Creating a Scene Button

To create a scene button:

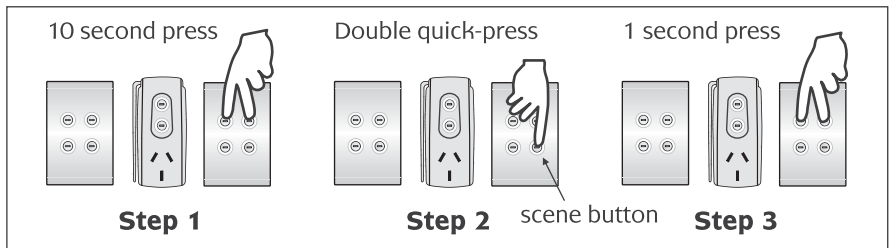

14.9 Learning a Scene

To learn a scene (after creating a scene button):

This example assumes that units are on the same network, and two groups and a scene button have been created.

Each group associates one or more free buttons with a local control button.

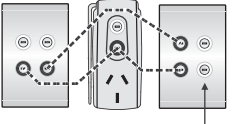

Groups scene button

10 second press

Set state of first group (set lighting level)

Set state of second group (switch plug adapter on)

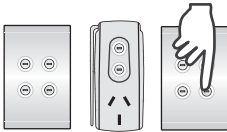

Step 1



Step 2

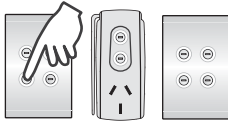

Step 3

1 second press

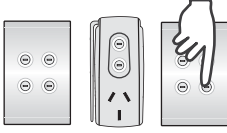

Step 4

After learning the scene, pressing the scene button will fade lights to the learnt level (first group), and switch the plug adapter on (second group).

15.0 Troubleshooting

Wall switches won't work

A globe may have blown. Wall switches need a functioning light or other appliance connected to the first output channel for them to work. (The first output channel is connected to the first button pair).

Wall switch relay unit makes a clicking sound every 3 seconds or so

A globe may have blown (as in above problem).

Unit won't enter learn mode. When the top two buttons are held down, one of the lights starts flashing

The flashing button indicates it has been set as a scene button. Ensure you press the non-scene button first, when entering learn mode.

Unit won't enter learn mode

Learn mode capability may have been disabled by special software.

Button won't select in learn mode

You can't select both a local control button and free button on the same wall switch. If a free button is already selected, quick-pressing a local control button will have no effect. If a local control button is already selected, quick-pressing a free button will have no effect.

Buttons on different units won't group together

Units must belong to the same network before you can group their buttons together. You can confirm that units are networked together by entering learn mode on one unit (press and hold the top two buttons for 10 seconds). All units in the same network enter learn mode simultaneously, and begin flashing. (To exit learn mode, press and hold the top two buttons again for 1 second). Refer to section 6.1, Creating a Network.

A switched load switches off again after 5 seconds

You may have accidentally set a button as a 5 second timer. This is a special mode used for testing purposes. It is activated while in learn mode by holding a button down for just under 1 second. To fix this, enter learn mode from a local control button pair that the 5 second timer is grouped to. Deselect and then reselect the 5 second timer button, and then exit learn mode. Refer to section 7.0, Grouping Buttons Together.

All indicators on a unit flash unusually for one minute (a quick flash about once per second)

This is a special flash pattern indicating that there has been a transmission failure. You can press a button on the unit to stop it flashing immediately.

All indicators on a unit continue to flash every 4 seconds

This is a special flash pattern indicating that the unit is offline. The unit is most likely only barely in range of other units, and has shut itself down to prevent it from causing network radio frequency (RF) traffic congestion. The unit will place itself back online after an hour.

Sometimes a light or other appliance cannot be controlled from a grouped button on a another unit

C-Bus Wireless uses an encryption system for added security. As a consequence of this, if a unit misses transmissions from other units (due to RF interference or being out of range), the unit may lose its ability to control other units.

The solution is to operate a grouped button on any unit nearby. This will re-synchronise the unit that is not transmitting. Sometimes simply operating the local control buttons a few times on the unit which is not transmitting will be sufficient. Note that the local control buttons will always operate the local load, even if the encryption system has lost synchronisation.

If this proves to be insurmountable because of a marginal installation (perhaps due to the building materials used), encryption can be turned off using special software.

16.0 Electrical Specifications

All Units

| Parameter | Description |
|---|---|
| Supply voltage | 220 to 240 Va.c. @50 Hz (except remote control) |
| Radio frequency | 433.92MHz |
| Transmitting power | Remote Control: 10mW; Other units: 1mW |
| Typical range (Range depends on building construction and the proximity to dense or metallic objects) | 15 to 20m (in buildings with timber frame/brick veneer construction) 10 to 15m (in buildings with brick, stone or steel frame construction) 5 to 10m (in buildings with steel reinforced concrete construction) |
| Maximum range | 50m (open air) |
| Control functions | Load switching, dimming (LE/TE only), timer, relay |
| Status indicator colour | Orange |
| Warm-up time | 5 seconds |
| Operating temperature range | 0 to 40°C |
| Operating humidity range | 10 to 95% RH |

Wall Switch Relay

| Parameter | Description | |
|---|------------------|-----------------|
| Min. load per channel | 25W, 0.1A | |
| Max. total load* | 2000W, 8A | |
| Compatible loads/ rating [†] | IEC | Australia/NZ |
| Incandescent/halogen | 8A | 8A |
| Fluorescent [†] | 4AX | 4AX |
| Iron core trans. LV lighting [§] | 8A | 8A |
| Electronic LV lighting | 8A | 8A |
| Fan motors [#] | 2A | 3M |
| Off state power consumption | 0.25W | |
| Off state leakage current | 10mA (channel 1) | 0mA (channel 2) |

PLEASE NOTE: Legend appears on page 28

Wall Switch Leading Edge Dimmer

| Parameter | Description | |
|---|--|---------------------|
| Min. load per channel | 25W lamp or 0.25 A fan motor ⁶ | |
| Max. load per channel | 500W, 2 A (one channel unit) 250W, 1 A (two channel unit) | |
| Compatible loads/ rating[†] | IEC | Australia/NZ |
| Incandescent/ halogen | 2A | 2A |
| Iron core trans. LV lighting [§] | 2A | 2A |
| Fan motors# | 2A | 3M |
| Off state power consumption | 0.5W | |
| Off state leakage current | 12mA (channel 1) 5mA (channel 2) | |

Wall Switch Trailing Edge Dimmer

| Parameter | Description | |
|---|--|---------------------|
| Min. load per channel | 25W lamp | |
| Max. load per channel | 500W, 2 A (one channel unit) 250W, 1 A (two channel unit) | |
| Compatible loads/ rating[†] | IEC | Australia/NZ |
| Electronic LV lighting | 2A | 2A |
| Off state power consumption | 0.5W | |
| Off state leakage current | 15mA (channel 1) 10mA (channel 2) | |

Plug Adapter Mechanical Specifications

| Parameter | Description |
|--------------------|-----------------|
| Dimensions (WxHxD) | 50 x 123 x 64mm |
| Weight | 118g |

Plug Adapter Relay

| Parameter | Description | |
|---|-------------|---------------------|
| Max. total load | 2400W, 10A | |
| Compatible loads/ rating[†] | IEC | Australia/NZ |
| Incandescent/ halogen | 10A | 10A |
| Fluorescent [†] | 4AX | 4AX |
| Iron core trans. LV lighting [§] | 10A | 10A |
| Electronic LV lighting | 10A | 10A |
| Fan motors [#] | 2A | 3M |

Plug Adapter Leading Edge Dimmer

| Parameter | Description | |
|---|-------------|---------------------|
| Max. total load | 750W, 3A | |
| Compatible loads/ rating[†] | IEC | Australia/NZ |
| Incandescent/ halogen | 3A | 3A |
| Iron core trans. LV lighting [§] | 3A | 3A |

Plug Adapter Trailing Edge Dimmer

| Parameter | Description | |
|---|-------------|---------------------|
| Max. total load | 500W, 2A | |
| Compatible loads/ rating[†] | IEC | Australia/NZ |
| Electronic LV Lighting | 2A | 2A |

* Total loading connected to a 2 channel model is the sum of load 1 and load 2.
Refer to Compatible loads / ratings for individual channel switch ratings for each load type.

† Fluorescent luminare must include a Power Factor Correction (PFC) capacitor in order for a switch unit to function correctly.

‡ See Important Notes (page 3)

§ Only iron core transformers compatible with electronic switches may be used to ensure compliance to IEC 60669-2-1.

Exhaust and ceiling fans with shaded pole or permanent split capacitor motors.

17.0 Mechanical Specifications

Refer to the C-Bus Wireless Wall Switch Series Installation Instructions for wall switch mechanical specifications.

C-Bus Wireless Plug Adapter

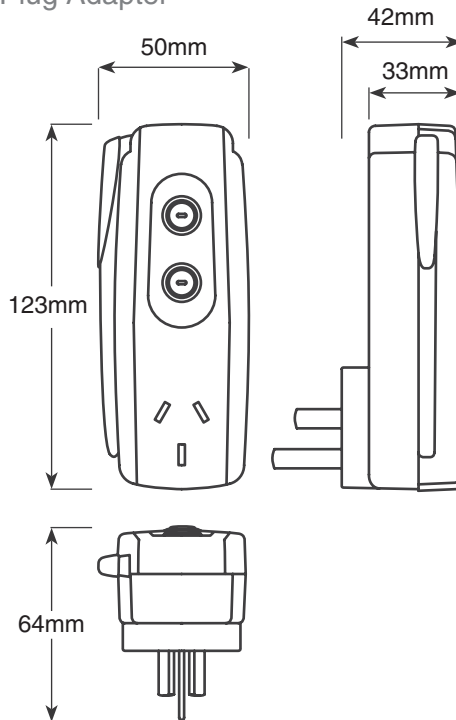

C-Bus Wireless Remote Control

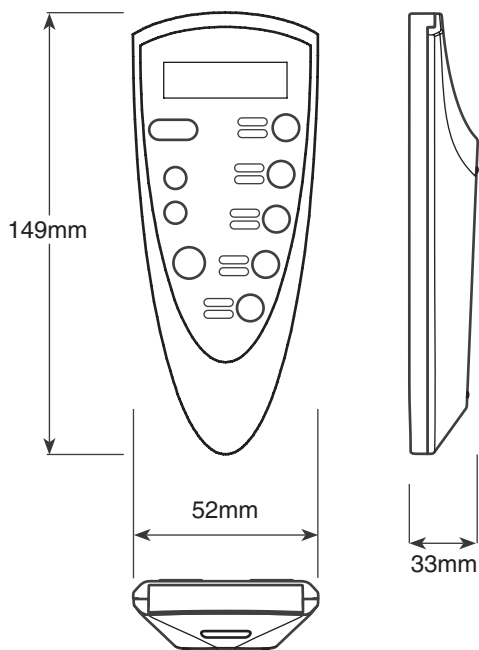

18.0 Warranty

C-Bus Wireless wall switch, plug adapter and remote control products carry a two year warranty against manufacturing defects (refer to the Warranty Statement).

19.0 Warranty Statement

The benefits conferred herein are in addition to, and in no way shall be deemed to derogate; either expressly or by implication, any or all other rights and remedies in respect to the Schneider Electric product, which the consumer has in the location where the product is sold.

The warrantor is Schneider Electric with offices worldwide.

This Schneider Electric product is guaranteed against faulty workmanship and materials for a period of two (2) years from the date of installation.

Schneider Electric reserves the right, at its discretion, to either repair free of parts and labour charges, replace or offer refund in respect to any article found to be faulty due to materials, parts or workmanship.

This warranty is expressly subject to the Schneider Electric product being installed, wired, tested, operated and used in accordance with the manufacturer's instructions. Any alterations or modifications made to the product without permission of Schneider Electric might void the warranty.

Schneider Electric shall meet all costs of a claim. However, should the product that is the subject of the claim be found to be in good working order, all such costs shall be met by the claimant.

When making a claim, the consumer shall forward the Schneider Electric product to the nearest Schneider Electric office. Provide adequate particulars of the defect within 28 days of the fault occurring. The product should be returned securely packed, complete with details of the date and place of purchase, description of load, and circumstances of malfunction.

Further Information

For further information about configuring this product and other C-Bus devices, please consult the documentation supplied. Further assistance can be obtained as follows:

- **C-Bus Installation Software**

The C-Bus Toolkit Software may be used to unlock the power and flexibility of Clipsal C-Bus. Unit operation may be completely customised to suit user requirements. Advanced control functions may be programmed.

- **C-Bus Installer Training Courses**

Contact your nearest Clipsal Integrated Systems Sales or Technical Support Officer and enquire about Clipsal C-Bus Installer Training and Certification Programs today.

- **Technical Support and Troubleshooting**

For further assistance, please consult your nearest Clipsal Sales Representative or Technical Support Officer.

| | |
|------------------------------------|-------------------------------|
| Technical Support Hotline: | 1300 722 247 (Australia only) |
| Technical Support Email | cis.support@clipsal.com.au |
| Sales Support Email | sales.cis@clipsal.com.au |
| Clipsal Integrated Systems Website | clipsal.com/cis |

20.0 Technical Support and Troubleshooting

For further assistance in using this product, consult your nearest Clipsal Sales Representative or Technical Support Officer.

| Technical Support Contact Numbers | |
|-----------------------------------|---|
| Australia | 1300 722 247 (Technical Support Hotline) |
| New Zealand | 0800 888 219 (Technical Support Hotline) |
| Northern Asia | +852 2484 4157 (Clipsal Hong Kong) |
| South Africa | 011 314 5200 (Technical Support) |
| Southern Asia | +603 7665 3555 Ext. 236 or 242 (CIS Malaysia) |
| United Kingdom | 0870 608 8 608 (Schneider Electric Support) |

Technical Support Email: cis.support@clipsal.com.au

Sales Support Email: sales.cis@clipsal.com.au

Worldwide contacts are provided at <http://www.clipsal.com/locations/>

Information and resources are provided at <http://www.clipsal.com/cis/>

Clipsal Australia Pty Ltd

A member of Schneider Electric

Contact us: clipsal.com/feedback

Tech help: cis.support@clipsal.com.au

National Customer Care Enquiries:

Tel 1300 2025 25

Fax 1300 2025 56

clipsal.com

Clipsal Australia Pty Ltd reserves the right to change specifications, modify designs and discontinue items without incurring obligation and whilst every effort is made to ensure that descriptions, specifications and other information in this instruction are correct, no warranty is given in respect thereof and the company shall not be liable for any error therein.

© Clipsal Australia Pty Ltd. The identified trademarks and copyrights are the property of Clipsal Australia Pty Ltd unless otherwise noted.