



Part 1: System Overview and Installation

Installation and Cabling
(for the **Installer**)

Part 2: Start-Up and Configuration

Software and Network
(for the **System Administrator**)

5 MP
Sensor

MxLEO



vPTZ



MxBus

USB

+50°
-30°

IP65



Innovations - Made in Germany

The German company MOBOTIX AG is known as the leading pioneer in network camera technology and its decentralized concept has made high-resolution video systems cost-efficient.

MOBOTIXAG • D-67722 Langmeil • Phone: +49-6302-9816-103 • Fax: +49-6302-9816-190 • sales@mobotix.com



T25-CamCore (camera module)

- Allround view with no blind spots
- Internal memory
- Speaker
- Microphone

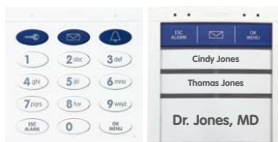

Access module (KeypadRFID or BellRFID)

- Keyless access (RFID and PIN)
- Operate voice mailbox
- Contact remote stations
- Incl. RFID transponder cards



Info Module/Info Module Mx2wire+

- With integrated Mx2wire+ unit (optional)
- Data and power (PoE) via two-wire connection
- Instead of connection via network cable
- For two-wire cables up to 500 m



MX-DoorMaster (indoors)

- Opens door, doorbell on/off
- Status LEDs for door and messages
- Backup power supply with battery
- Connects to door opener and sensors

SYSTEM MANUAL PART 1 – SYSTEM OVERVIEW AND INSTALLATION

This *T25 System Manual Part 1, «System Overview and Installation»* is supplemented by the *T25 System Manual Part 2, «Start-Up and Configuration»*. If you no longer have a manual at your disposal, you can download a PDF file from the MOBOTIX website (www.mobotix.com > **Support** > **Manuals**).

CONTENTS

Foreword	8
Hemispheric IP Video Door Station	10
Allround View Without Blind Spots	12
Overview Of Modules	14
Individual Components: Outdoors	16
Individual Components – Indoors	18
Configuration Examples	20
System Image	22
1 System Overview	24
1.1 Outdoor Station	24
1.1.1 Hemispheric Camera T25-CamCore	24
1.1.2 ETH Module (Ethernet Terminal Board)	26
1.1.3 Access Module KeypadRFID	28
1.1.4 Access Module BellRFID	30
1.1.5 Info Module	32
1.1.6 Info Module Mx2wire+ (With Mx2wire+ Indoor Unit)	34
1.1.7 Housing and Module Frames	38
1.2 MX-DoorMaster	44
1.3 Remote Stations	46
1.3.1 MxEasy Video Management Software	46
1.3.2 MOBOTIX App	47
1.3.3 Grandstream IP Video Telephone GXV3140	48

1.4	Accessories	50
1.4.1	NPA-PoE Set	50
1.4.2	IO Module (Extended Terminal Board)	51
1.4.3	MX-Overvoltage-Protection-Box	51
1.4.4	MX-GPS-Box	52
1.4.5	Additional Devices for PoE Power Supply	52
1.4.6	Additional Video Remote Stations	53
1.4.7	Door Sensors	53
1.4.8	Electrical Door Opener	53
2	Installation	54
2.1	Overview: Connection and Wiring Diagrams	54
2.1.1	With MX-DoorMaster	56
2.1.2	Without MX-DoorMaster	54
2.1.3	With Info Module Mx2wire+ and MX-DoorMaster	58
2.1.4	Recommendation for Cabling	60
2.1.5	Installation Tip: Replacing an Existing Doorbell by a T25	62
2.2	Remote Stations and Network Connection	64
2.2.1	Notes on Cable Lengths and Power Supply	64
2.2.2	Direct Connection of One Remote Station	64
2.2.3	Network Connection with Multiple Remote Stations	65
2.3	Mounting the Frame and Housing	68
2.3.1	Determining the Installation Position	68
2.3.2	Inserting the Cables	70
2.3.3	Attaching the Housing	72
2.3.4	Cabling in the On-Wall Housing	74
2.3.5	Mounting the Terminal Board and Fitting the Network Cable	76
2.3.6	Applying the Gasket	77
2.3.7	Attaching the Frame and Connecting the Theft Protection	78
2.3.8	Mechanical Theft-Protection Lock	80
2.4	Installing the T25 Modules	82
2.4.1	Installing the T25-CamCore Camera Module	82
2.4.2	Preparing the BellRFID Access Module	86
2.4.3	Installing the Access Module (KeypadRFID/BellRFID)	88
2.4.4	Installing the Info Module	92
2.4.5	Installing the Info Module Mx2wire+	94
2.4.6	Labeling the Info Module	96
2.4.7	Removing, Exchanging and Modifying Modules	98
2.5	Installing the MX-DoorMaster	100
2.5.1	Overview of Connectors	100
2.5.2	Connection Diagrams for Door Opener Versions	102
2.5.3	Mounting Instructions	104
2.5.4	Installation Using Cavity or In-Wall Socket	107

2.6	Installing the Mx2wire+ Indoor Unit	110
2.6.1	Overview of Mx2wire+ Technology and Connectors	110
2.6.2	Mounting Instructions	112
2.6.3	Installation Using Cavity or In-Wall Socket	113
2.6.4	Installation With Surface-Mounted Socket	115
2.6.5	Function of Mx2wire+ Status LEDs	117
2.7	Connecting External Devices to the Door Station	118
2.7.1	Using the IO Module	118
2.7.2	Using the Signal Outputs of the Access Module (KeypadRFID/BellRFID)	122
2.8	Finishing the Installation	124
2.8.1	Checking the Wiring and Activating Theft Protection	124
2.8.2	Configuring the MX-DoorMaster	126
Manufacturer		131

MOBOTIX Seminars

MOBOTIX offers inexpensive seminars that include workshops and practical exercises. For more information, visit www.mobotix.com > **Seminars**.

Copyright Information

All rights reserved. *MOBOTIX*, the MX logo, *MxControlCenter*, *MxEasy* and *MxPEG* are trademarks of MOBOTIX AG registered in the European Union, the U.S.A., and other countries. *Microsoft*, *Windows* and *Windows Server* are registered trademarks of Microsoft Corporation. *Apple*, the Apple logo, *Macintosh*, *OS X*, *iOS*, *Bonjour*, the Bonjour logo, the Bonjour icon, *iPod* and *iTunes* are trademarks of Apple Inc. registered in the U.S.A. and other countries. *iPhone*, *iPad*, *iPad mini* and *iPod touch* are Apple Inc. trademarks. *Linux* is a trademark of Linus Torvalds. All other marks and names mentioned herein are trademarks or registered trademarks of the respective owners.

Copyright © 1999-2014 MOBOTIX AG, Langmeil, Germany. Information subject to change without notice!

Download the latest version of this and other manuals as PDF files from www.mobotix.com > **Support** > **Manuals**.



Legal Notes

Legal aspects of video and sound recording: You must comply with all data protection regulations for video and sound monitoring when using MOBOTIX products. Depending on national laws and the installation location of the T25, the recording of video and sound data may be subject to special documentation or it may be prohibited. All users of MOBOTIX products are therefore required to familiarize themselves with all valid regulations and comply with these laws. MOBOTIX AG is not liable for any illegal use of its products.



Safety Warnings

Installation Instructions:

- This product must not be used in locations exposed to the dangers of explosion.
- Make sure to install this product as shown in *Chapter 2, «Installation»* of this manual.
- When installing this product, make sure that you are only using genuine MOBOTIX parts and MOBOTIX connection cables.
- Make sure that you are installing this product on a solid surface that provides for a sturdy installation of the fixing elements used.

Electrical installation: Electrical systems and equipment may only be installed, modified and maintained by a qualified electrician or under the direction and supervision of a qualified electrician in accordance with the applicable electrical guidelines. Make sure to properly set up all electrical connections.

Electrical surges: MOBOTIX cameras are protected against the effects of small electrical surges by numerous measures. These measures, however, cannot prevent the camera from being damaged when stronger electrical surges occur. Special care should be taken when installing the camera outside of buildings to ensure proper protection against **lightning**, since this also protects the building and the whole network infrastructure.

Max. power consumption of attached extension modules: The power consumption of all attached **MxBus modules** must **not exceed 2.5 W**. When attaching modules to the MxBus connector **and** the USB connector, the **power consumption of all attached modules must not exceed 3 W, if the camera is powered by PoE class 3**. If **PoE class 2** is used, **the power consumption of all attached modules must not exceed 1 W!**

Risk of overheating when exposed to direct sunlight: When mounting a black, dark gray or amber-colored T25 IP Video Door Station in locations where the device is exposed to direct sunlight, the housing temperature can exceed the maximum allowed temperature limit. This can result in electronic failures and injuries especially when touching exterior metal parts. If the intended use of the device is at an (unprotected) outdoor location, you should only install white or silver-colored modules and frames. This product must not be installed within the reach of persons without the dome.

Power off before opening the camera: Make sure the power supply is disconnected before opening the camera (i.e., for installing or replacing sensor modules and SD cards).

Network security: MOBOTIX products include all of the necessary configuration options for operation in Ethernet networks in compliance with data protection laws. The operator is responsible for the data protection concept across the entire system. The basic settings required to prevent misuse can be configured in the software and are password-protected. This prevents unauthorized parties from accessing these settings.



FOREWORD

Dear MOBOTIX customer,

Congratulations on your decision to purchase an exceptionally versatile and innovative IP Video Door Station "made in Germany." **The T25 system contains a hemispheric door camera with a 5 megapixel color sensor (T25-CamCore) and captures the entire room 180° from wall to wall and from floor to ceiling without any blind spots.**



Another plus – the improved light sensitivity of the 5MP sensors, which drastically reduces exposure times. In conjunction with MxLEO, the exposure and image optimization program working in the background, the camera generates perceptibly better and more detailed images especially under low-light conditions. This significantly reduces motion blur that is typical of longer exposure times with little light and thus provides much more image detail (faces, etc.) for proper identification.

Chapter 1 of this manual contains all product details and the technical information of the system. *Chapter 2* deals with the installation of the T25 with a direct network connection or the optional connection via two (existing) wires. The *T25 System Manual Part 2* will demonstrate how you operate the door station and configure it to meet your specific needs. The system manuals are supplemented by the *T25 Quick Guide*.

If you would like to use a computer for the installation or as a remote station, make sure to use the free MOBOTIX operating software MxEasy. You can download MxEasy and its manual free of charge from the **Support** section on the MOBOTIX website.

If you have any questions, our support and international sales staff are available at intl-support@mobotix.com and sales@mobotix.com Monday to Friday, 8 a.m. to 6 p.m. (German time). Calling support is free of charge (not including your connection costs).

We would like to thank you for your trust and wish you all the best with your new high-performance MOBOTIX IP Video Door Station.

Security-Vision-Systems



© MOBOTIX AG • Security-Vision-Systems • Made in Germany

www.mobotix.com • sales@mobotix.com



More security thanks
to a maximum overview

What Are the Specific Advantages of A MOBOTIX IP Video Door Station?

The new IP Video Door Station from MOBOTIX offers an innovative, powerful solution that is easy to install and takes a different approach to the solutions available on the market up to now. The T25 is based on the international video telephony standard VoIP/SIP with H.264 and G.711. All of the modules offered for outdoor use are weatherproof, maintenance-free and can be used in temperatures ranging from -30 to $+50^{\circ}\text{C}/-22$ to 122°F . Here are the most important system advantages at a glance:

Allround View Without Blind Spots

With 5 megapixel image sensor and internal memory, this hemispheric door camera records the entire entrance area. No blind spots from wall to wall and from floor to ceiling.

Two-Way Video Communication Worldwide

When the doorbell rings, a connection is established with an IP video phone or a standard computer via the network. For two-way video communication and for opening the door.

Recording With Sound

The camera in the door station can record events automatically. For example, when someone rings the doorbell or if something moves in front of the door.

Keyless Access

Who has access and who doesn't? The door opener can be controlled tamper-proof using the KeypadRFID with a PIN code or an RFID transponder.

Integrated Message Function

Digital voice messages for residents can be left directly at the door station and played back after authentication.

Very Simple Installation

The door station is connected to the network via an Ethernet cable or via two-wire cabling thanks to Mx2wire+ technology.

The T25 modules are available individually or in a set



MOBOTIX integrates hemispheric technology into existing systems of third-party manufacturers, thus providing added security thanks to superior overview images and event-controlled recording of video and sound.



Fisheye view

Which Advantages Does MOBOTIX Offer Over Other Video Door Stations?

Thanks to its HiRes image quality, decentralized technology and a wide range of features, MOBOTIX offers not only an outstanding door camera but also a professional security camera in a single device. **MOBOTIX Hemispheric Video Technology** was successfully introduced to the network video market in 2008. This technology is an important component of the MOBOTIX video door stations, which provide perfect, high-resolution overview images thanks to a fisheye lens with a 180° image angle. This allows the camera to cover the entire entrance area from wall to wall and from floor to ceiling without any blind spots, and without ever needing to mechanically pan or tilt.

But the camera, with its unrivaled image quality and panoramic view, is much more than just a modern "door spy." The camera has an integrated high-speed processor that provides a range of functions similar to those available in MOBOTIX security cameras used in banks and airports. Thanks to the **integrated Video Motion Detection**, when the camera registers movement in the image or detects suspicious noises, it automatically starts recording **smooth**

video with sound while simultaneously sending an **e-mail or SMS** to the residents of the building or to a security company.

In addition, a **message may be left for the residents** at the door station; it works just like a telephone answering machine with the addition of video and audio recording by the camera module. Additionally, an **audio message for visitors** can be played back automatically when the doorbell button is pushed.

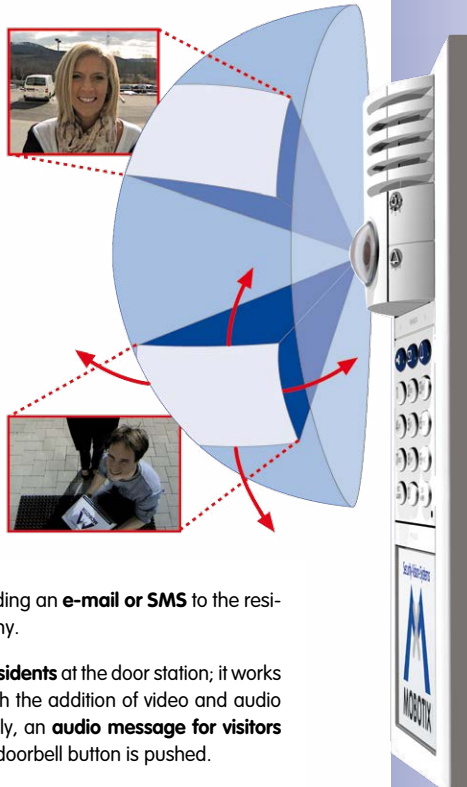

HD Super 180° Panorama

The camera captures the entire hemispherical area in front of the camera lens and displays it in a user-friendly format as a corrected image or image section, or as an HD Super 180° panorama

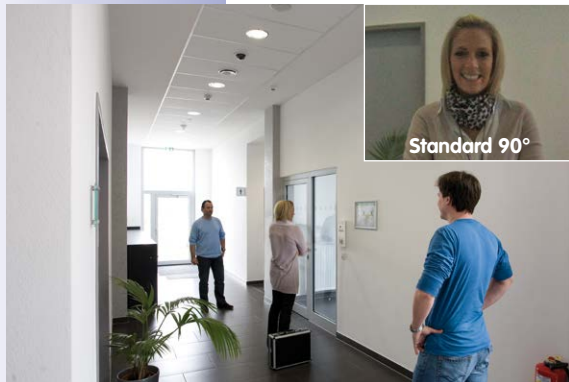

Seeing the entire scene with the T25

Hemispheric HiRes Camera

Thanks to the fisheye lens with its 180° image angle, the camera records the entire entrance area without having to be mechanically panned or tilted – **without any blind spots, from wall to wall, floor to ceiling**. It's impossible to "slip by" this camera. On the monitor located at the remote station, the operator can change the current image section in seconds: from a close-up of the visitor all the way to an overview panorama.

The hemispheric T25-CamCore door camera has a virtual, purely digital PTZ feature (pan/tilt/zoom). The image captured by the hemispheric camera can be zoomed smoothly, and you can simultane-

ously move to any section of the image in seconds, for example, using the mouse or the four large arrow keys on the Grandstream video telephone (left, right, up, down). This is similar to a mechanical PTZ camera, but without the maintenance and wear.

A Superior Overview Increases Security

The fisheye lens of the camera records the entire hemisphere of the scene without any blind spots and displays this image as the first part of the 360° full image. Here, there are technical limitations - predominantly at the edges of the image, where the geometric shape of the objects is heavily distorted, making them difficult for the human eye to evaluate.



T25 360° Full Image



Original IMOBOTIX T25 Image: 1280x 480

For this reason, the camera uses its integrated software to correct the images in the live view so that it can deliver user-friendly images at the remote video station. The operator can now **digitally tilt, pan and zoom** the image from the comfort of the remote station.

180° Field of View Without Blind Spots

Conventional door cameras have a standard 90° lens, meaning that they are only able to capture visitors standing directly in front of the lens. However, much of the time, the door station is not mounted in the immediate vicinity of the door, so the camera is at an angle to the visitor (see image). Even in this case, **thanks to its 180° image angle, the T25 delivers perfect images**.

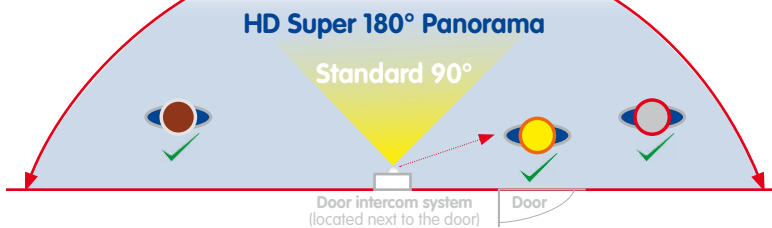

Original MOBOTIX T25 Image

Right: Original
MOBOTIX T25 image

Direct Views Up and Down

And the hemispheric camera can do much, much more: it can record the area on the floor in front of the door, for example, even the often overlooked area underneath the door station. **And the T25 does all of this using only its software – without the need for moving parts or motors.** This camera is silent, discreet and unobtrusive.

Original MOBOTIX
T25 image (enlarged
image section)

Also, this quick look down is incredibly practical when checking, for example, whether the daily paper is already in front of the door. Of course, it is also possible to look upwards under the ceiling as well.



5-Megapixel Image Sensor Technology

The latest 5-megapixel image sensor technology used in the camera has improved the frame rate as well as the image quality for the camera images with max. QXGA resolution and brings a new level of detail to your zoomed images (+26 %) Thanks to the new sensors that feature a nearly four times higher light sensitivity, the camera also delivers convincing color images at dusk and in heavy rainfall. At night, the optional black and white sensor now also provides HiRes images up to QXGA size (the predecessor T24 offered a max. of 1.3 megapixels only). This means that the camera can deliver live or recorded QXGA images day or night.

Product Overview: T25 Modules

In addition to the hemispheric HiRes camera, the latest MOBOTIX development also includes a multifunctional access module with transponder technology for keyless access and control of message functions. This module is available either with a keypad for PIN-code access (KeypadRFID) or as a bell button module with interchangeable button sets (BellRFID).

A particular advantage of the T25 is the minimal amount of cabling involved – either a standard Ethernet cable (for example, CAT7) or existing bell wire is sufficient to connect the door station to the network in the building and to supply it with power. Only a PoE switch is necessary to connect remote stations (VoIP video phone or computer) and supply power. The PoE switch can be located in an electrical cabinet, for example.



Hemispheric Door Camera with Allround View and No Blind Spots (T25-CamCore)

With 5 megapixel image sensor and internal storage, this hemispheric door camera records the entire entrance area. No blind spots from wall to wall and from floor to ceiling. The camera can record events automatically. For example, when someone rings the doorbell or if something moves in front of the door. The camera module with a remote station can be used as a compact basic video door station thanks to the integrated doorbell and light buttons. The camera saves high-resolution video with lip-synchronous sound directly to the integrated MicroSD flash card (up to 64 GB) without requiring an external storage device or computer and with no additional network load. The storage space is for up to 800,000 panorama images or 66 hours of video recordings.



Access Modules with Contactless RFID Technology (KeypadRFID or BellRFID)

Both MOBOTIX-developed modules can be used for several functions. Outdoors, the function as an access control interface, either by entering a code (KeypadRFID) or by means of keyless access using a transponder (e.g., the supplied RFID cards). Instead of a keypad, the BellRFID module uses illuminated bell buttons, which can be labeled using the free-of-charge labeling service on the MOBOTIX website. The layout of the bell buttons is variable and can be adjusted anytime later. The modules can also be used by visitors and residents to record and play back messages (video mailbox). **Please note that you can currently attach only one access module (i.e., either KeypadRFID or BellRFID) to an IP Video Door Station.**

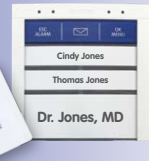

Info Module without/with Mx2wire+ Technology (Info Module/Info Module Mx2wire+)

The info module features a backlit house number field and may also include an optional Mx2wire+ unit. This unit is needed if the outdoor station is to be connected to the PoE switch with an existing bell wire via a second Mx2wire+ indoor unit instead of directly using an Ethernet cable.



Door Opener Module with Backup Power Supply (MX-DoorMaster)

The door station may be coupled with a MX-DoorMaster with access code memory, making it impossible to open the door by forcibly removing the system and bypassing the connecting cable. A built-in rechargeable battery powers both the electrical door opener and the access module in the outdoor station and guarantees that the door can be accessed using a transponder or PIN even in the case of power failure. For indoor installations, the MX-DoorMaster also functions as a doorbell. The device features two status LEDs and two function buttons (doorbell, door opener).







T25 Components: Outdoors

The camera module is also available with a particularly light-sensitive B/W sensor (MX-T25M-SecNight-N12)

One admin and several user RFID cards are included with an access module (KeypadRFID/BellRFID)

The indoor unit is always part of the Info Module Mx2wire+

Terminal boards		
	ETH Module: Securely connects the camera module with the mounted 8 wires of the network patch cable via RJ45 connector. Only for T25 versions without Mx2wire+.	MX-OptH02
	IO Module: The board provides an additional 8 signal inputs and 3 signal outputs to connect external devices (doorbell, light, etc.).	MX-OptH01
Modules		
	T25-CamCore: Fisheye lens (for 360° panorama view) and integrated live image correction, high-resolution 5 megapixel color sensor, speaker, microphone and 4 GB data storage for approx. 250 one-minute video clips or 60,000 VGA images.	MX-T25M-Sec-D12
	KeypadRFID/BellRFID access module: Keyless and scheduled access using key codes (KeypadRFID) or an RFID transponder card. Interchangeable bell buttons with high-quality labels (BellRFID). The voice mailbox can also be operated via the access module.	MX-Keypad-EXT MX-Bell-Core
	Info Module: Provides the option to display the house number and/or name to the door station. The module is equipped with permanent backlighting using energy-saving and long-lasting LED technology.	MX-Info-EXT
	Info Module Mx2wire+: The info module with Mx2wire+ technology and a second Mx2wire+ unit for mounting inside the building offers users not only the standard info module functions but also the option to connect and supply power to the door station via existing two-wire cabling instead of a network cable.	MX-2wirePlus-Info-EXT
Frame		
	Single frame: 131 x 143 x 18 mm (W x H x D). Integrated electromagnetic anti-theft protection. Includes special key for module unlocking, housing gasket and installation material.	MX-OptFrame-1-EXT
	Double frame: 131 x 233 x 18 mm (W x H x D). Integrated electromagnetic anti-theft protection. Includes special key for module unlocking, housing gasket and installation material.	MX-OptFrame-2-EXT
	Triple frame: 131 x 333 x 18 mm (W x H x D). Integrated electromagnetic anti-theft protection. Includes special key for module unlocking, housing gasket and installation material.	MX-OptFrame-3-EXT

On-wall housing		
	Single on-wall housing: 126 x 138 x 31 mm (W x H x D). Metal-reinforced housing.	MX-OPFBox-1-EXT-ON
	Double on-wall housing: 126 x 227 x 31 mm (W x H x D). Metal-reinforced housing.	MX-OPFBox-2-EXT-ON
	Triple on-wall housing: 126 x 327 x 31 mm (W x H x D). Metal-reinforced housing.	MX-OPFBox-3-EXT-ON
In-wall housing (incl. plasterwork protection)		
	Single in-wall housing: 123 x 138 x 52 mm (W x H x D). The in-wall housing is securely connected with the subsurface or brick work. It can also be used to ensure easy installation in cavities.	MX-OPFBox-1-EXT-IN
	Double in-wall housing: 123 x 228 x 52 mm (W x H x D). The in-wall housing is securely connected with the subsurface or brick work. It can also be used to ensure easy installation in cavities.	MX-OPFBox-2-EXT-IN
	Triple in-wall housing: 123 x 328 x 52 mm (W x H x D). The in-wall housing is securely connected with the subsurface or brick work. It can also be used to ensure easy installation in cavities.	MX-OPFBox-3-EXT-IN

The required flush-mounting opening has the following dimensions (width x height):

Single housing:
117 x 129 mm

Double housing:
117 x 218 mm

Triple housing:
117 x 318 mm

T25 Components: Indoors

The Mx2wire+ indoor unit is always part of the Info Module Mx2wire+

Free download at
www.mobotix.com

MX-DoorMaster With Backup Power Supply		
	The T25 may be coupled with the MOBOTIX MX-DoorMaster with internal access code memory and battery for back-up power supply, making it impossible to open the door by forcibly removing the system and bypassing the connecting cable.	MX-Door2-INT-PW
Mx2wire+ Indoor Unit		
	An Info Module Mx2wire+ set always consists of two devices that communicate with one another. For this reason, the Info Module Mx2wire+ in the door station also requires a corresponding Mx2wire+ unit to connect to the network and to supply power.	MX-2wirePlus-Info-EXT
Remote Stations		
	IP video telephone: MOBOTIX recommends the GXV3140 from Grandstream as a remote video station for the T25 door station. This modern IP video telephone is based on the world standard in telephony - VoIP/SIP with H.264 - and provides a large color LCD display with excellent image quality.	Grandstream GXV3140
	MxEasy video management software: MOBOTIX provides the MxEasy software (for Windows, Mac and Linux) free of charge to configure and operate the IP Video Door Station with a network-enabled desktop or notebook computer.	Free of charge
Accessories		
	NPA-PoE-Set: The MOBOTIX Network Power Adapter Set (NPA-PoE set) is a high-quality, robust, ultra-compact, and - above all - multifunctional PoE injector with three connectors (network, camera/PoE device, computer) and a universal power supply unit with adapter plugs. The Network Power Adapter Set remotely supplies the T25 door station and all other PoE devices with power in accordance with the IEEE 802.3af standard. It is therefore possible to secure the power supply for distances up to 100 m (300 ft) using the network cable. As a result, the IP Video Door Station can be supplied with PoE power via the adapter and connected directly to a Grandstream video telephone or to a computer (integrated crossover function).	MX-NPA-PoE set

T25 – the Custom-Made IP Video Door Station

The T25 product line is a modular system that can be adapted to any customer needs. This highly robust and weatherproof outdoor station (IP65, -30 to +50°C/-22 to 122°F) is available in four attractive colors: white, silver, dark gray, black and amber.



Only white and silver-colored IP Video Door Stations should be exposed to direct sunlight (risk of overheating on dark surfaces)

The color abbreviation is added at the end of the order number in each case (for example, white T25-CamCore: MX-T25M-Sec-D12-PW)

You will find the T25 online configurator tool on the MOBOTIX website, which you can use to plan your individual T25 door station.

You can choose the individual components step-by-step so that no individual component is forgotten. Accessories required for your selected components are automatically added by the configuration tool.

After you have finished the configuration, the system creates a preview image of the system as well as a parts list, which you can hand to your electronics specialist for an installation quote.

The web configurator can be found on the MOBOTIX website under the main menu item **Products > T25 Configurator**.

www.mobotix.com >
Products > T25
Configurator

T25 – a Future-Oriented System

With the T25, MOBOTIX offers a new product range for the home automation market and it will be extended and complemented with other new products.

The most recent example is the **BellRFID bell button module** with one to five keys and integrated RFID technology. And the best part for all MOBOTIX customers: all future T25 innovations are also compatible with T25 systems that have already been purchased.



Various configuration examples in all available MOBOTIX colors

Only white and silver-colored IP Video Door Stations should be exposed to direct sunlight (risk of overheating on dark surfaces)



Camera in single frame (PW)



Camera in single frame (SV)



Camera in single frame (DG)



Camera in single frame (BL)



Camera in single frame (AM)



Camera and KeypadRFID in double frame (PW)



Camera and KeypadRFID in double frame (SV)



Camera and KeypadRFID in double frame (DG)



Camera and KeypadRFID in double frame (BL)



Camera and KeypadRFID in double frame (AM)

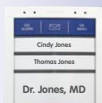

BellRFID access module is also available in all colors!



Camera and info module in double frame (PW)



Camera and info module in double frame (SV)



Camera and info module in double frame (DG)



Camera and info module in double frame (BL)



Camera and info module in double frame (AM)



Camera, KeypadRFID and info module in triple frame (PW)



Camera, KeypadRFID and info module in triple frame (SV)



Camera, KeypadRFID and info module in triple frame (DG)



Camera, KeypadRFID and info module in triple frame (BL)



Camera, KeypadRFID and info module in triple frame (AM)



T25 with KeypadRFID

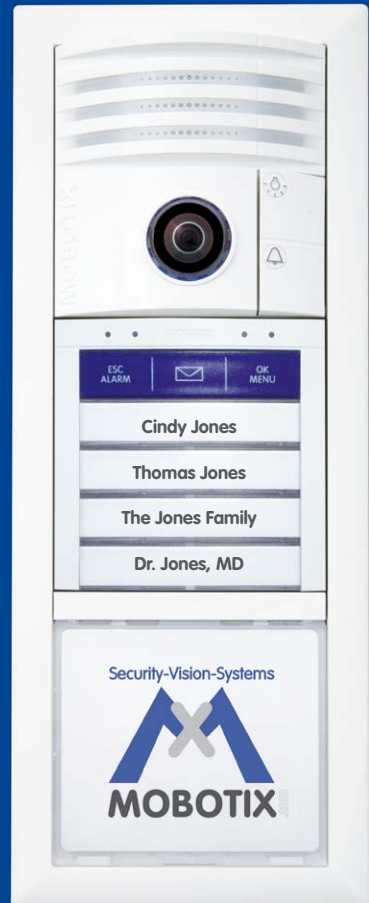

T25 with BellRFID

SYSTEM OVERVIEW: IP VIDEO DOOR STATION

What does a typical system look like and what components are included? This section describes the setup for a complete system with a video door station including a MX-DoorMaster, KeypadRFID and Info Module Mx2wire+ with Mx2wire+ technology to connect the door station using existing two-wire cabling. In newer buildings, it is preferable to lay an Ethernet cable directly to the door.

Hemispheric camera (with LEDs)

- Two-way video communication
- Lip-synchronous sound
- Event-controlled recording
- Outdoor light and doorbell button

Access module (KeypadRFID/ BellRFID)

- Open/lock door
- Keyless access (RFID and PIN)
- Operate voice mailbox

Info Module (backlit)

- With Mx2wire+ technology (optional)
(Data transfer and power supply via two-wire connection)

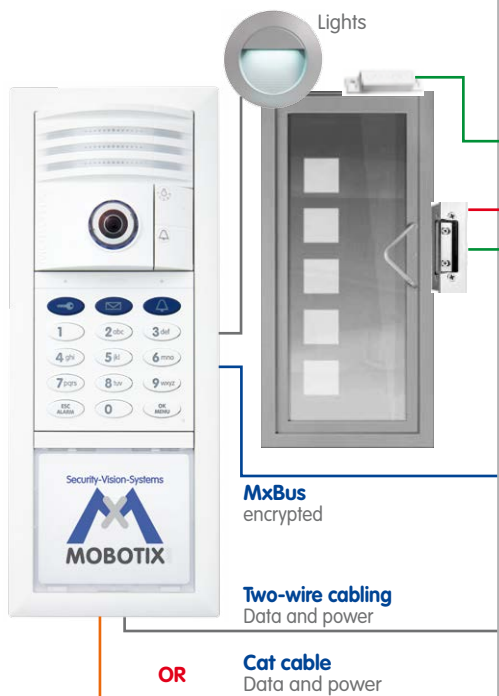

MxBus two-wire cabling:

- Data (9,600 baud) and power (PoE)
- Max. 8 devices to be connected
- Encrypted data transfer
- Power supply and control via camera

Worldwide access using
Internet connection



iOS device (iPhone, iPad, iPad mini, iPod touch)

- Free-of-charge **MOBOTIX App** (via App Store)
- For iOS devices with iOS 5 or higher
- Operation of the T25 IP Video Door Station
- All functions including two-way communication
- Connection via WiFi/UMTS (3G)/LTE (4G)



Computer (remote station)

- Free MOBOTIX MxEasy software
- T25 configuration and operation
- All functions including two-way video communication
- Connection via Ethernet/WLAN

Global access over any Internet connection

Door contact

Door opener

Door lock switch



MX-DoorMaster

- Open door, doorbell on/off
- Status LEDs for door and messages
- Backup power supply with battery
- Connection of door opener and sensors



Mx2wire+ Indoor Unit

- Remote station for unit in the info module
- Data transfer and power supply via two-wire connection
- Alternative to standard Ethernet cable
- Power input with PoE+ switch or 48-57 V DC, 600 mA power supply unit

Network connection

Connection to switch, router

PoE switch/PoE+



Network connection

Connection to switch, router

Internet connection

Worldwide access



VoIP video phone (ground floor remote station)

- Two-way video communication, open door, turn light on/off
- Operate camera (including image correction)
- Monitor door status (open/closed/locked)
- Recording and event search
- Voice mailbox player



1 SYSTEM OVERVIEW

1.1 Outdoor Station

1.1.1 Hemispheric Camera T25-CamCore

The hemispheric camera with its fisheye lens (for a 360° panorama view) and integrated live image correction boasts a high-resolution 5-megapixel image sensor (color or black&white), speaker, microphone and 4 GB data storage for approx. 250 one-minute video clips or 60,000 VGA images.



Technical Specifications: T25-CamCore	
Model versions	Secure, Secure-Night (T25M-Sec-Night-N12)
Lens options	L12 Hemispheric 360°
Sensitivity	Color version: 1 lux (t = 1/60 s), 0.05 lux (t = 1/1 s) B/W version: 0.1 lux (t = 1/60 s), 0.005 lux (t = 1/1 s) MxLEO – MOBOTIX Lowlight Exposure Optimization
Image sensor	1/2.5" CMOS, 5 megapixels, progressive scan
Max. image resolution	Color and B/W: 2048x1536 (QXGA)
Image formats	2048x1536 (QXGA), 1920x1080 (Full HD), 1280x960 (MEGA), 1280x720 (HD), 1024x768, 800x600, 768x576 (D1-PAL), 704x576 (TV-PAL), 640x480, 384x288, 320x240, 160x120, custom formats
Max. frame rate (M-JPEG) (live/recording)	VGA: 30 fps, MEGA: 10 fps, QXGA: 4 fps
Max. video stream (MxPEG) (live/recording/audio)	VGA: 30 fps, MEGA: 30 fps, QXGA: 20 fps
Image compression	MxPEG, M-JPEG, JPEG, H.264
Internal DVR	4 GB MicroSD card (camera-internal recording, max. 64 GB usable)
External video storage	Directly on NAS and Computer/Server without additional recording software
Software (included)	MxEasy video management software, MOBOTIX App for iOS devices with iOS 5.0 or higher
Image processing	Backlight compensation, automatic white balance, image correction (incl. panorama image correction), video sensor (motion detection)
Virtual PTZ	Digital pan/tilt/zoom (continuous 8x zoom)
Alarm/events	Triggering of events through integrated multiple-window motion detection, temperature sensor, notification over email, FTP, IP telephony (VoIP, SIP), visual/acoustic alarm, pre- and post-alarm images
Audio	Microphone, speaker, G.711, lip-synchronous sound
Video telephony	VoIP/SIP, two-way video communication, remote controlling with key code, event notification
Security	User/group management, HTTPS/SSL, IP address filter, IEEE 802.1x, intrusion detection, digital image signature
Certificates	EMC [EN 55022, CISPR 22, EN 55024, EN 61000-6-1/2, FCC Part15B, CFR 47, AS/NZS 3548]
Power supply	Power over Ethernet (PoE in accordance with IEEE802.3af): PoE class variable depending on operating mode; power consumption: typically 4.5 W; via PoE switch/MOBOTIX PoE adapter/Mx2wire+
Operating conditions	IP65 (DIN EN 60529), -30 to +50°C/-22 to 122°F (DIN EN 50155)
Interfaces	Ethernet 10/100, IPv4/IPv6, MiniUSB, MxBus; inputs/outputs, RS232 via accessories
Dimensions (W x H)	99 mm x 99 mm

The camera is also available in a version with a black and white sensor (extremely light-sensitive sensor)

1.1.2 ETH Module (Ethernet Terminal Board)

The Ethernet terminal board ETH Module is used to connect the door station for the T25 versions **without Mx2wire+ technology**. It securely connects the camera module with the 8 connected wires of the network patch cable via RJ45 connector (for installation, see *Chapter 2*).

ETH Module



Caution

Only use **original MOBOTIX cables** to connect the camera.

Standard cables purchased from other suppliers do not meet the necessary specifications for proper fastening (not impermeable/weatherproof).



Ethernet patch cable

The Ethernet terminal board is screwed on to the housing (on-wall or in-wall) behind the camera module.



Alternatively, the extended terminal board IO Module can be used to connect external devices, such as a doorbell

1.1.3 Access Module KeypadRFID

This module is used for keyless and scheduled access to the house or building with an access PIN or RFID transponder card.

In addition, the KeypadRFID module allows leaving and retrieving messages on the video mailbox.

Included in delivery:
One admin RFID card
for initial operation and
activating user cards



Included in delivery:
Several user RFID cards
for opening the door and
video mailbox access



Additional cards (admin/
user) can be ordered
from MOBOTIX

Please note that you
can currently attach
only one access module
(i.e., either KeypadRFID
or BellRFID) to an
IP Video Door Station.

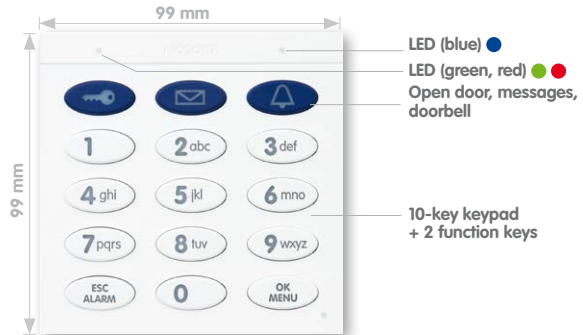

View with housing cover removed



Technical Specifications: KeypadRFID	
Functions	Keyless access using RFID card and PIN
Interface	MxBus
User interfaces	RFID (13.56 MHz, Mifare DESFire EV1), illuminated keys, acoustic feedback
Inputs	2 galvanically separated inputs (AC/DC, self-powered, up to 48 V)
Outputs	1 insulated relay output (AC/DC, -48 V/60 W/2 A)
Sensors	Illumination sensor
Protection class	IP65 (DIN EN 60529)
Operating temperature	-30 to +50°C/-22 to +122°F (DIN EN 50155)
Power supply	MxBus
Power consumption	typically 1 W
Dimensions (W x H)	99 mm x 99 mm

In the case of a power failure, the access module and the door opener are supplied with power from the battery of the MX-DoorMaster

Technical Specifications: Terminals Used On The KeypadRFID	
Cable cross-section, solid	min. 0.14 mm ² /max. 0.5 mm ²
Cable cross-section, flexible	min. 0.2 mm ² /max. 0.5 mm ²
Cable cross-section, flexible, with wire-end sleeves without plastic sleeves	min. 0.25 mm ² /max. 0.5 mm ²
Cable cross-section AWG/kcmil	min. 24/max. 20
AWG according to UL/CUL	min. 26/max. 20

Recommended wire diameter: 0.6 to 0.8 mm

1.1.4 Access Module BellRFID

This module is used for keyless and scheduled access to the house or building with an RFID transponder card and also has bell buttons for up to five parties (depending on the selected bell button set).

In addition, the BellRFID module allows leaving and retrieving messages on the video mailbox.

Included in delivery:
One admin RFID card for initial operation and activating user cards



Included in delivery:
Several user RFID cards for opening the door and video mailbox access



Additional cards (admin/user) can be ordered from MOBOTIX

Please note that you can currently attach **only one access module** (i.e., either KeypadRFID or BellRFID) to an IP Video Door Station.

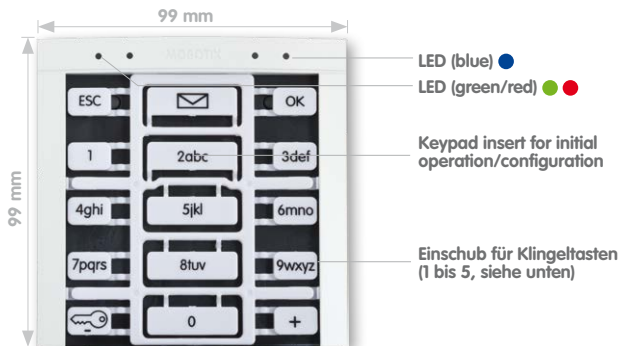

Available Button Sets



MX-Bell1-Button-F1
Large bell button with function button



MX-Bell1-Button-F2
2 medium-size bell buttons with function button



MX-Bell1-Button-F3
1 large, 2 small bell buttons with function button



MX-Bell1-Button-F4
4 small bell buttons with function button



MX-Bell1-Button-05
5 small bell buttons (no function button)



MX-Bell1-Button-XL1
XL bell button (no function button)

Back view with cover removed



Technical Specifications BellRFID	
Features	Keyless access using RFID card with 1 to 5 bell buttons (depending on button set)
Interface	MxBus
User interfaces	RFID (13.56 MHz, Mifare DESFire EV1), backlit bell buttons, sound feedback
Inputs	2 galvanically separated inputs (AC/DC, self-powered, up to 48 V)
Outputs	1 insulated relay output (AC/DC, up to 48 V/60 W/2 A)
Sensors	Illumination sensor
Protection class	IP65 (DIN EN 60529)
Operating temperature	-30 to +50°C/-22 to +122°F (DIN EN 50155)
Power Supply	MxBus
Power consumption	typ. 1 W
Measurements (width x height)	99 mm x 99 mm

Technical Specifications: Terminals Used on the BellRFID module	
Cable cross-section, solid	min. 0,14 mm ² /max. 0,5 mm ²
Cable cross-section, flexible	min. 0,2 mm ² /max. 0,5 mm ²
Cable cross-section, flexible with wire-end sleeves, without plastic sleeves	min. 0,25 mm ² /max. 0,5 mm ²
Cable cross-section, AWG/kcmil	min. 24/max. 20
AWG according to UL/CUL	min. 26/max. 20

In the case of a power failure, the BellRFID module and the door opener are powered by the battery of the MX-DoorMaster

Recommended wire diameter: 0.6 to 0.8 mm

1.1.5 Info Module

The standard info module provides the option to attach the house or building number and/or name to the door station. The module is equipped with permanent backlighting using energy-saving and long-lasting LED technology.



Technical Specifications: Info Module	
Functions	Information for visitors on nameplate (name, street number, etc.)
Interfaces	MxBus
User interfaces	Backlit, printable foil (UV-protected)
Protection class	IP65 (DIN EN 60529)
Operating temperature	-30 to +50°C/-22 to 122°F (DIN EN 50155)
Power supply	MxBus
Power consumption	typically 0.2 W
Dimensions (W x H)	99 mm x 99 mm

Technical Specifications: Terminals Used on the Info Module	
Cable cross-section, fixed	min. 0.14 mm ² /max. 0.5 mm ²
Cable cross-section, flexible	min. 0.2 mm ² /max. 0.5 mm ²
Cable cross-section, flexible, with wire-end sleeves without plastic sleeves	min. 0.25 mm ² /max. 0.5 mm ²
Cable cross-section AWG/kcmil	min. 24/max. 20
AWG according to UL/CUL	min. 26/max. 20

Recommended wire diameter: 0.6 to 0.8 mm

Note on Labeling

You will find some PDF templates, which you can print out yourself, on the MOBOTIX website (www.mobotix.com).

1.1.6 Info Module Mx2wire+ (With Mx2wire+ Indoor Unit)

The info module with Mx2wire+ technology, combined with a second Mx2wire+ unit to be mounted inside the building, offers users not only the standard info module functions but also the option to connect and supply power to the door station via two-wire cabling instead of a network cable (see *Section 1.1.6*). Advantage: Simple and cost-effective installation thanks to reuse of already existing two-wire cabling.

The two status LEDs (orange, green) are activated for test purposes within the first 15 minutes after the info module has been powered up

A PoE+ switch or an external voltage connection (48-57 V DC, 600 mA) can be used

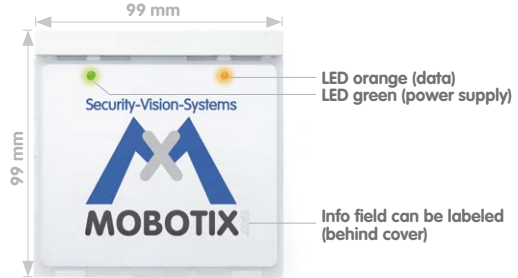

View with housing cover removed

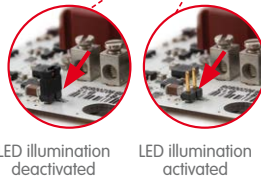
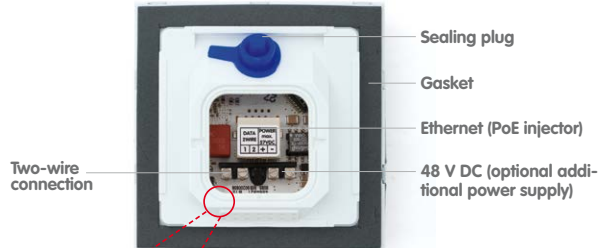

To activate the LED illumination of the module, you need to cautiously remove the small black jumper on the circuit board (using tweezers or small pliers) before mounting the module itself.

Technical Specifications: Info Module Mx2wire+

Data transfer rate	Up to 50 Mbps net (depending on distance)
Interfaces	Ethernet (PoE injector), Mx2wire+ indoor unit, 48-57 V DC, 600 mA (optional additional supply)
Certificates	EMV (EN55022, EN55024, EN61000-6-1, FCC part15B, AS/NZS3548)
Protection class	IP65 (DIN EN 60529)
Operating temperature	-30 to +50°C/-22 to 122°F (DIN EN 50155)
Connecting wire thickness	Cable cross-section 0.14 to 2.5 mm ² , diameter 0.4 to 1.6 mm
Dimensions (W x H)	99 mm x 99 mm

Note On Labeling

You will find some PDF templates, which you can print out yourself, on the MOBOTIX website (www.mobotix.com).

Standard Two-Wire Cabling (Installed in Buildings)

Analog Telephone Line or Bell Wire

- Cable type: JY, A2Y and YR (telephone and low-voltage cable)
- Very good availability in buildings
- Core diameter 0.6 to 0.8 mm
- Range (at 50 Mbps): 100 m (0.6 mm), 200 m (0.8 mm)



Power Line (Should No Longer Be Live)

- Cable type: NY (installation cable)
- Widespread availability of cables
- Cables must be disconnected from the power supply!
- Wire cross-section max. 1.5 mm²
- Range (at 40 Mbps): 300 m

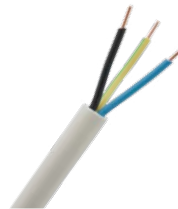

Safety Warning

Use this product in compliance with the applicable legal regulations. Electrical systems and equipment may only be installed, modified and maintained by a qualified electrician or under the direction and supervision of a qualified electrician in accordance with the applicable electrical guidelines.



Mx2wire+ Indoor Unit

An Mx2wire+ set always consists of two devices that communicate with one another. For this reason, the necessary unit to connect to the network and to supply power is included with the Info Module Mx2wire+ info module in the door station.



Power supply with PoE+ switch or 48-57 V DC, 600 mA (power supply unit)





48-57 V DC (optional additional power supply)

Two-wire connection Info Module Mx2wire+



Technical Specifications: Mx2wire+ Indoor Unit	
Data transfer rate	Up to 50 Mbps net (depending on distance)
Interfaces	Ethernet (PoE Class 3), Mx2wire+ info module, 48-57 V DC, 600 mA (optional additional supply)
Certificates	EMV (EN55022, EN55024, EN61000-6-1), FCC part15B, AS/NZS3548)
Power supply	PoE+ (PoE IEEE802.3af), performance-related 7 Watt own consumption or 48-57 V DC, 600 mA SELV power supply unit
Status display	LED green (network connection, power supply), LED orange (data transfer via AB conductor is active, door station connected)
Protection class	IP20 (DIN EN 60529)
Operating conditions	-5 to +40°C/+23 to +104°F (DIN EN 50155)
Connecting wire thickness	Cable cross-section 0.14 to 2.5 mm ² , diameter 0.4 to 1.6 mm
Dimensions (W x H x D)	80 mm x 80 mm x 38 mm (in-wall version), 80 mm x 80 mm x 45 mm (on-wall version)

Max. Cable Lengths of Usable Cable Types as Two-Wire Cable of an IP Video Door Station

Cable type	Cable thickness	Max. cable length
Antenna or coaxial cable 	0.6 mm (inner core)	100 m (50 Mbps)
Telephone line/ bell wire 	0.6 mm	100 m (50 Mbps)
	0.8 mm	200 m (50 Mbps)
Installation cable 	1.5 mm ²	300 m (40 Mbps)
Network installation cable 	Cat7	500 m (45 Mbps)

Notes
<p>The Mx2wire+ set consisting of two units (info module and indoor unit) contains all the components required to establish an Ethernet connection via a two-wire cable.</p> <p>Please note that the two Mx2wire+ units are matching pairs and preconfigured at the factory. The use of a different Mx2wire+ unit that was not supplied in the original packaging is therefore technically not possible. In case of a defect, both units must always be exchanged for a new Mx2wire+ pair that has been configured by MOBOTIX.</p>

Mx2wire+ pair for T25: Info Module Mx2wire+ module with Mx2wire+ indoor unit

1.1.7 Housing and Module Frames

The robust IP Video Door Station can be installed in both on-wall and in-wall systems, it is weatherproof (IP65) and cannot be stolen. The system consists of a housing and a frame. The frame for mounting the modules is simply screwed on to the housing used.

On-Wall Housing (Fig. Triple Housing)

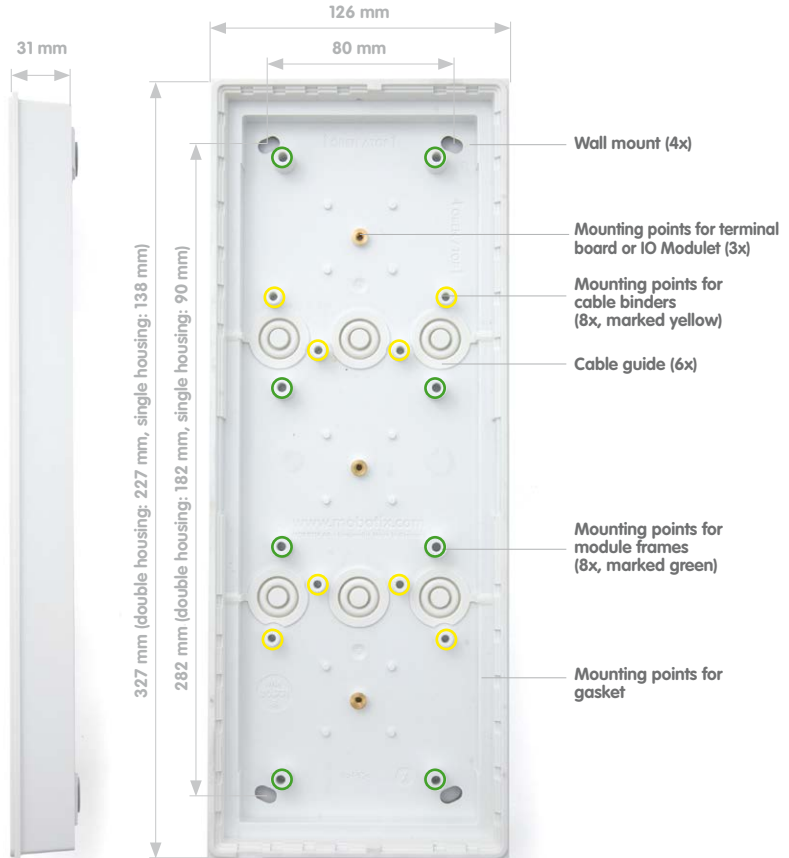



In-Wall and Cavity Housing (Fig. Triple Housing)

The blue housing is firmly connected to the subsurface or brick work. It can **also be used to ensure easy installation in cavities**: Drill opening, position housing and screw tightly in place; the retaining wings, which automatically swing out, secure the housing, while the plastic bars at the edge of the housing prevent it from sliding into the cavity.

The insert prevents the in-wall housing from getting dirty or being deformed during installation

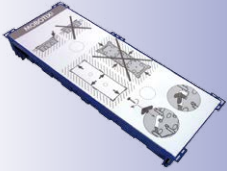

The required integration opening has the following dimensions (width x height):

Single housing:
117 x 129 mm

Double housing:
117 x 218 mm

Triple housing:
117 x 318 mm

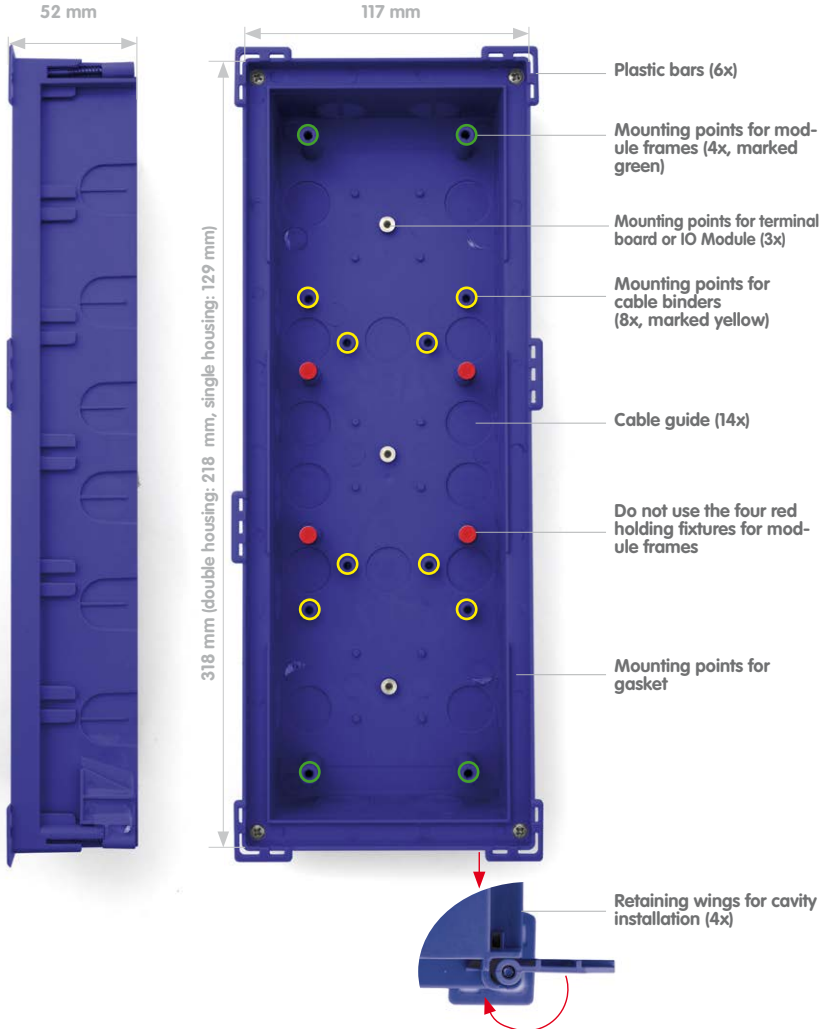



Permissible wall thickness for cavity installation:
min. 7 mm/max. 27 mm



Module Frame (Fig. Triple Frame)

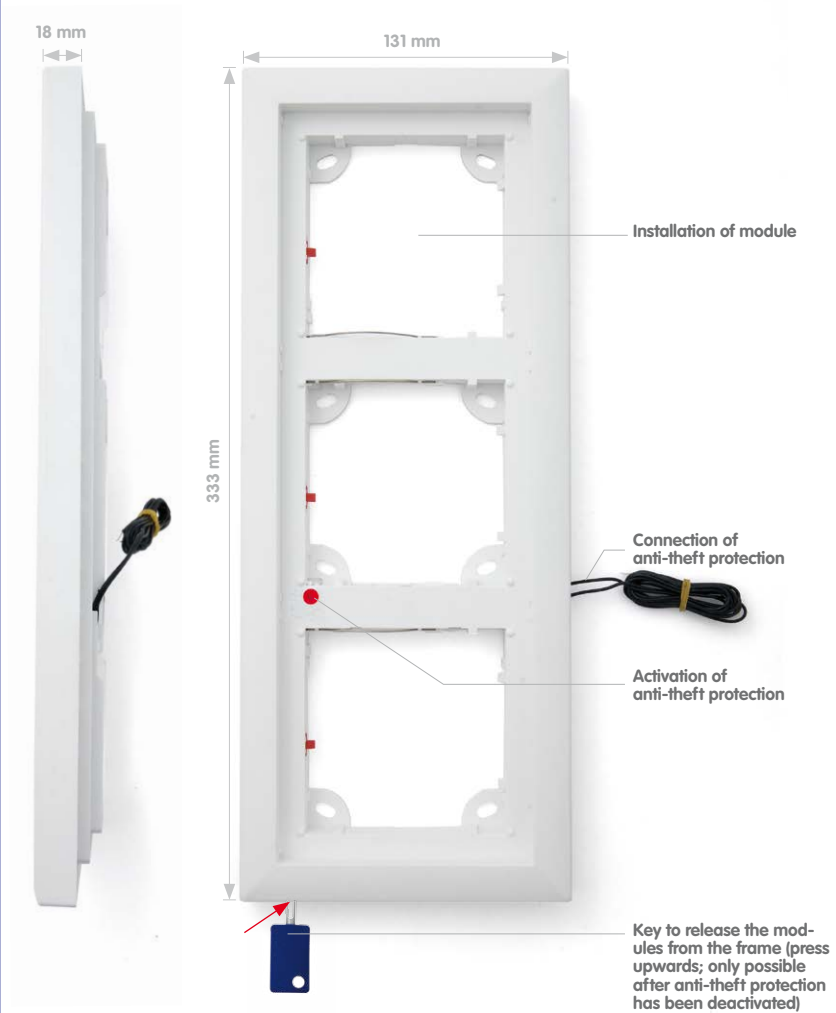

T25-Modules
T25-CamCore,
KeypadRFID,
Info Module/Info Module Mx2wire+

Frame
With integrated
anti-theft
protection

Terminal board*
Ethernet terminal
board or
Info Module

Housing
On-wall or
in-wall
housing



* Ethernet terminal board ETH Module is not required when using Mx2wire+ technology

1.2 MX-DoorMaster

The T25 can be coupled with the MX-DoorMaster with internal access code memory, making it impossible to open the door by forcibly removing the system and bypassing the connecting cable.

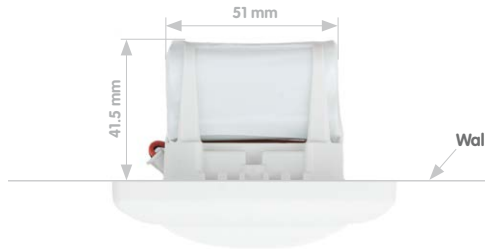
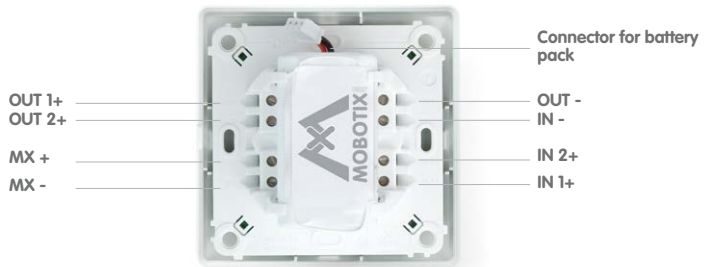

Minimum mounting dimensions:

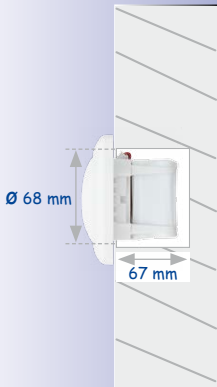

Technical Specifications: MX-DoorMaster	
Functions	Security door opener with internal access code memory
Interfaces	MxBus (max. 50 m distance to door station)
User interfaces	2 status LEDs, 2 function buttons, integrated speaker (doorbell)
Inputs	2 galvanically separated inputs with shared ground connection (AC/DC, self-powered – 48 V)
Outputs	1 isolated relay output (AC/DC, 24 V/1 A) or 1 connector for standard door opener (6-12 V AC) 1 output for MOBOTIX anti-theft protection (12 V DC)
Protection class	IP20 (DIN EN 60529)
Operating temperature	-5 to +40°C/+23 to +104°F (DIN EN 50155)
Power supply	MxBus
Power consumption	typically 1 W
Output	max. 10 W
Switch time	max. 5 s
Connecting wire thickness	Cable cross-section 0.14 to 2.5 mm ² , diameter 0.4 to 1.6 mm
Dimensions (W x H x D)	80 mm x 80 mm x 41.5 mm

Max. cable length for MxBus is 50 m

Note

The **battery pack** supplies the electrical door opener and, in the event of a power failure, the access module, which continues to guarantee that the door can be unlocked multiple times. For installations in living areas, the MX-DoorMaster functions also as a doorbell.

Thanks to the battery, the door opener continues to function in the event of a power failure

Supported Door Versions

An electrically-operated standard door opener (6 to 12 V AC, min. nominal resistance 10 ohm, no support for closed-circuit current function) can be connected directly to the MX-DoorMaster and powered by its integrated battery pack. It is not necessary to connect an additional power supply unit.

By integrating an additional power supply unit, door openers with up 24 V AC/DC (max. 1 A) or a self-locking door lock (e.g., Mediator) can be connected.

1.3 Remote Stations

1.3.1 MxEasy Video Management Software

MOBOTIX provides the MxEasy software free of charge to configure and operate the IP Video Door Station with a network-enabled desktop or notebook computer. In principle, there is no need for a computer to handle configuration or operation when there is a simple application scenario (one door station only, IP video telephone as remote station).

MxEasy allows you to quickly and efficiently implement and control a video security system of 1 to 16 MOBOTIX cameras, making it the perfect choice for all small and mid-sized surveillance systems and the IP Video Door Station. The program automatically detects all installed cameras/door stations - even in non-administered networks - and carries out the initial configuration. You are not required to have an in-depth knowledge of network technology.

MxEasy enables the user to conveniently control the most important functions of the connected door station. Virtual zooming, panning and tilting in the live image is just as easy as using the live two-way video communication with the visitor, opening the door or activating recording. The video data recorded by the cameras can then be viewed and exported in different formats, such as H.264, at a later time.

MxEasy – Simple Operation of the Most Important Camera Functions

- Cameras can be installed without any knowledge of networks
- Supports up to 16 MOBOTIX cameras
- Time- or event-controlled recording
- Time-controlled motion detection, image brightness and microphone
- For Microsoft Windows and Mac OS X



1.3.2 MOBOTIX App

Premium solution: There for you whenever and wherever you need it, the MOBOTIX App serves as the perfect remote mobile station that uses intelligent detailed solutions to increase security and convenience for users on a daily basis. The controls are optimized for use with touchscreen devices and feature three main views (Live, Player, Events), self-explanatory symbols, large software buttons, multifunctional sliders developed by MOBOTIX as well as simple gestures like swipe and tap, making it easy for newcomers and older users to work with professional security equipment. In addition, using mobile devices to operate the various functions such as door opening, activating the voice mailbox, switching the door bell off at night and switching a light on/off, creates added value in the form of greater convenience and security in every day life.

MOBOTIX App – Mobile Remote Station for MOBOTIX Cameras and Door Stations

- Bandwidth-optimized remote access via WLAN (WiFi) or the Internet
- Live images and recordings in the best MOBOTIX HiRes quality
- Two-way communication, door opening and video mailbox access
- Doorbell and alarm notifications, protection of privacy
- Convenient search functions, playback of external MxPEG videos
- Grouping of cameras and filtering of events
- Free from the **App Store** for the iPad, iPad mini, iPhone and iPod touch



Free download from
the **App Store**

No license fees
Free updates



1.3.3 Grandstream IP Video Telephone GXV3140

MOBOTIX recommends the GXV3140 from Grandstream as a remote video station for the IP Video Door Station. This modern IP video telephone is based on the world standard in telephony, VoIP/SIP with H.264, and provides a large color LCD display with excellent image quality. The device is conveniently operated via a MOBOTIX user menu.

Basic T25 functions can also be controlled using the phone keys



Extensive Multimedia Facilities

The GXV3140 from Grandstream includes important features such as transfer, hold and conference calling for use in a professional environment, in addition to numerous multimedia functions. The full duplex speaker phone is equipped with an acoustic echo canceller for noise suppression.

The integrated camera can be switched on or off at the touch of a button. Additional multimedia features include: a multimedia player for data from a USB stick or SD card, display of RSS feeds and access to Internet radio.

The device also includes two Fast Ethernet connectors, a USB port (for external keyboards etc.) and an SD card slot, so you can easily transfer and use your own data with the phone. The integrated 2.5 mm connector allows you to attach a headset, and the video images can be displayed on an external monitor using the A/V jack.

Note

In principle, other IP video telephones (with H.264 and G.711) can also be used as a remote station for the IP Video Door Station. Due to the technical specifications of a particular device (display size, audio functions, etc.), however, it cannot be guaranteed that all T25 remote station functions of the Grandstream GXV3140 are available.

See also:
www.grandstream.com

1.4 Accessories

1.4.1 NPA-PoE Set

The MOBOTIX Network Power Adapter Set (NPA-PoE set) is a high-quality, robust, ultra-compact, and - above all - multifunctional PoE injector with three connectors (network, camera/PoE device, computer) and a universal power supply unit with adapter plugs. The Network Power Adapter Set supplies the IP Video Door Station and all other PoE devices with power in accordance with the IEEE 802.3af standard. It is therefore possible to secure the power supply for distances up to 100 m (300 ft) using the network cable. As a result, the IP Video Door Station can be supplied with PoE power via the adapter and connected directly to a remote station (integrated crossover function).

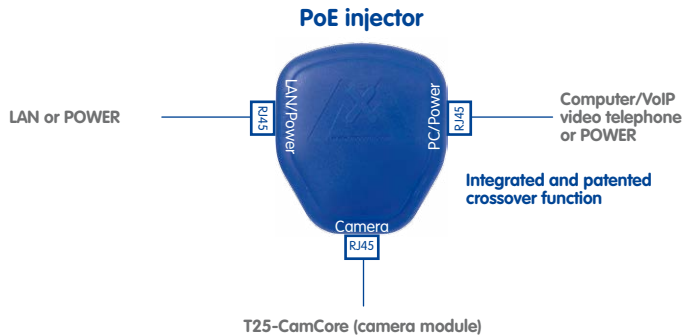

This device is especially practical because the supplied **power supply unit** can be used around the world by changing the adapters as required in just two simple steps. The "E.U." version of the NPA-PoE Set is supplied as standard with a European adapter, while the "INT" version includes four adapters (EU, USA, UK, AUS). Another product benefit is the option to connect to power sources from 12 V to 57 V that are independent of the network, which is ideal for solar and battery operation of the door station (e.g., in a holiday home).

MX-NPA-PoE-Set-EN
and MX-NPA-PoE-Set-
INT incl. adapter for
EU, US, UK and AUS



1.4.2 IO Module (Extended Terminal Board)

In addition to the Ethernet terminal board (ETH Module), MOBOTIX offers an IO Module (MX-OPT-IO1) with extended connection options for the door station (e.g., doorbell buttons, light, garage door opener, etc.).

The board provides 8 switch inputs and 3 switch outputs. The network cable and the camera module T25-CamCore are connected in the same manner as the Ethernet terminal board.



Note

Please read further information on the connection details and on using this product in *Section 2.7.1, «Using the IO Module»*.

1.4.3 MX-Overvoltage-Protection-Box

Order no.: MX-Overvoltage-Protection-Box-RJ45

Order no.: MX-Overvoltage-Protection-Box-LSA

Weatherproof network connector (protection class IP65, -30 to +60°C/-22 to +140°F) **with surge protection of up to 4 kV for MOBOTIX IP cameras**, ideal for replacing the MX-Patch-Box.

At the same time, the MX-Overvoltage-Protection-Box provides a weatherproof connection of a camera's patch cable to a network patch cable (-**RJ45** variant) or a network installation cable (-**LSA** variant).



1.4.4 MX-GPS-Box

Order no.: MX-OPT-GPS1-EXT

The MX-GPS-Box primarily serves as a high-precision time source for systems without an Internet connection. In addition, it can provide triggering based on GPS events (reaching or moving away from a specified position; exceeding or not reaching a specified speed). This interface box can be attached to all MOBOTIX cameras with an MxBus interface.



The MX-GPS-Box is equipped with the same compact housing as the other interface boxes (protection class IP65, -30 to $+60^{\circ}\text{C}/-22$ to $+140^{\circ}\text{F}$). This interface box should not be installed inside of other wall mounts, but on the exterior of the building with a large section of open sky above it. This ensures the best possible reception from GPS satellites and thereby the highest possible accuracy of the received GPS data. The maximum length of the MxBus wiring (0.8 mm diameter wires) is 50 m/55 yd.

1.4.5 Additional Devices for PoE Power Supply

By default, power is supplied to the IP Video Door Station via the network cable that is connected to the Ethernet terminal board behind the camera module. **PoE injectors or switches with integrated PoE power supply according to IEEE 802.3af** can be used to supply power to the network.

PoE switch



PoE+ According to IEEE 802.3at for Mx2wire+

If the T25 version with Mx2wire+ technology is installed, data and power are supplied to the door station via a two-wire cable, which is connected to the network via an Mx2wire+ indoor unit. Due to the increased energy requirements of the Mx2wire+ technology, PoE supply according to IEEE 802.3af is not sufficient. **A PoE injector/switch (performance class PoE+ according to IEEE 802.3at) has to be used instead, or an external voltage source (48 V DC) must be connected to one of the two Mx2wire+ units** (info module or indoor unit).

Info Module Mx2wire+
with Mx2wire+ indoor unit



Switch or PoE Injector?

A switch connects individual network-enabled devices to one another and delivers data. In the case of a home network, this function is normally performed by an existing router with multiple network ports, which is also capable of connecting to the Internet (such as the Fritz!Box). In this case and if only one T25 door station needs to be supplied with power, it is sufficient to purchase one PoE injector.

When purchasing a switch with an additional PoE power supply, make sure that a sufficient number of ports are supported (this is especially important if other PoE-supplied devices apart from the T25 are connected to the switch).

Furthermore, it is crucial that the switch fulfills all the requirements for using the PoE-supplied door station outdoors (electromagnetic compatibility, lightning and surge protection through galvanically-separated ports).

1.4.6 Additional Video Remote Stations

Thanks to the use of network technology, the T25 is not bound to just one expensive, manufacturer-dependent remote station. It can be connected to any suitable VoIP video phone (video: H.264, sound: G.711) in the world. In addition to supporting the two-way video communication feature with video and sound, these devices support additional features such as door/light control, image search, quick recording and PTZ functions. So called SIP softphones are also suitable as remote video stations.

1.4.7 Door Sensors

Connection options are also provided on the door station for conventional door and door lock switches (open/close door, open/close lock).

1.4.8 Electrical Door Opener

The T25 Door Station should always be connected to an electrical door locking system, which can be activated via the MX-DoorMaster in a tamper-proof manner.

Product Information: Self-Locking Door Lock

Traditional door openers only electromechanically release a locking tab on the door. In order to open an additional, key-locked door without using the key and as described above, **a door lock that can be locked/unlocked electrically is required instead of a traditional door opener (e.g., Mediator, www.assaabloy.de).**

This also applies when the door in question has to be locked at all times for insurance reasons and the keyless door opening function of the T25 is to be used as well (transponder/PIN).

2 INSTALLATION

2.1 Overview: Connection and Wiring Diagrams

The following diagrams are an overview of the wiring plans that will allow you to connect the IP Video Door Station as intended. Please refer closely to the configuration that best suits your particular needs.

2.1.1 With MX-DoorMaster

Using a **MX-DoorMaster with decentralized access code memory makes it impossible to open the door by bypassing the connection cable, thereby protecting your system against unauthorized access.** A battery, kept fully charged via MxBus at all times, supplies power to the electric door opening mechanism - even in the case of a power failure.

The figure above the connection sections represents the number of cable wires

Black: YSTY 0.8 (recommended) or 0.6 mm

Orange: Ethernet Cat. 5 or higher

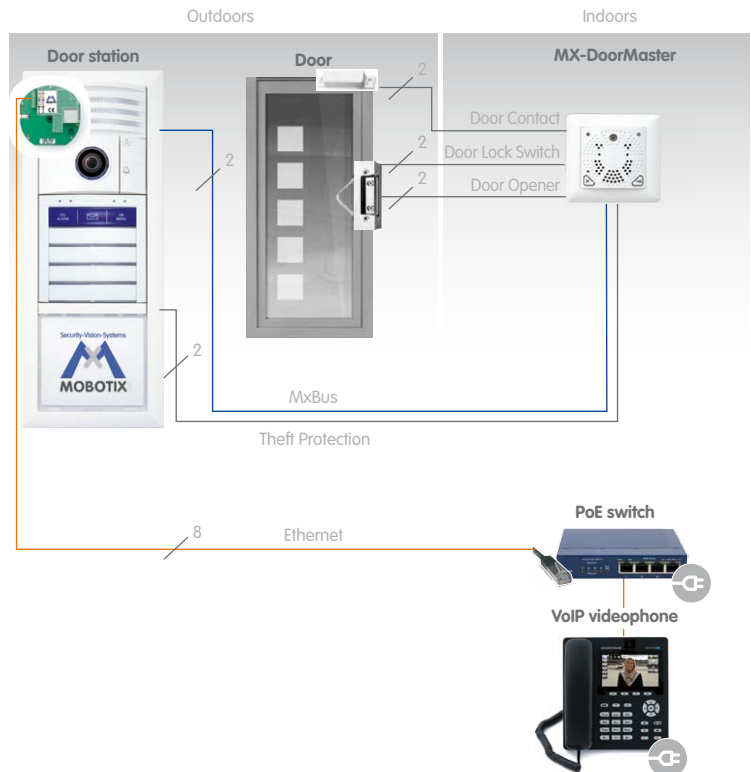

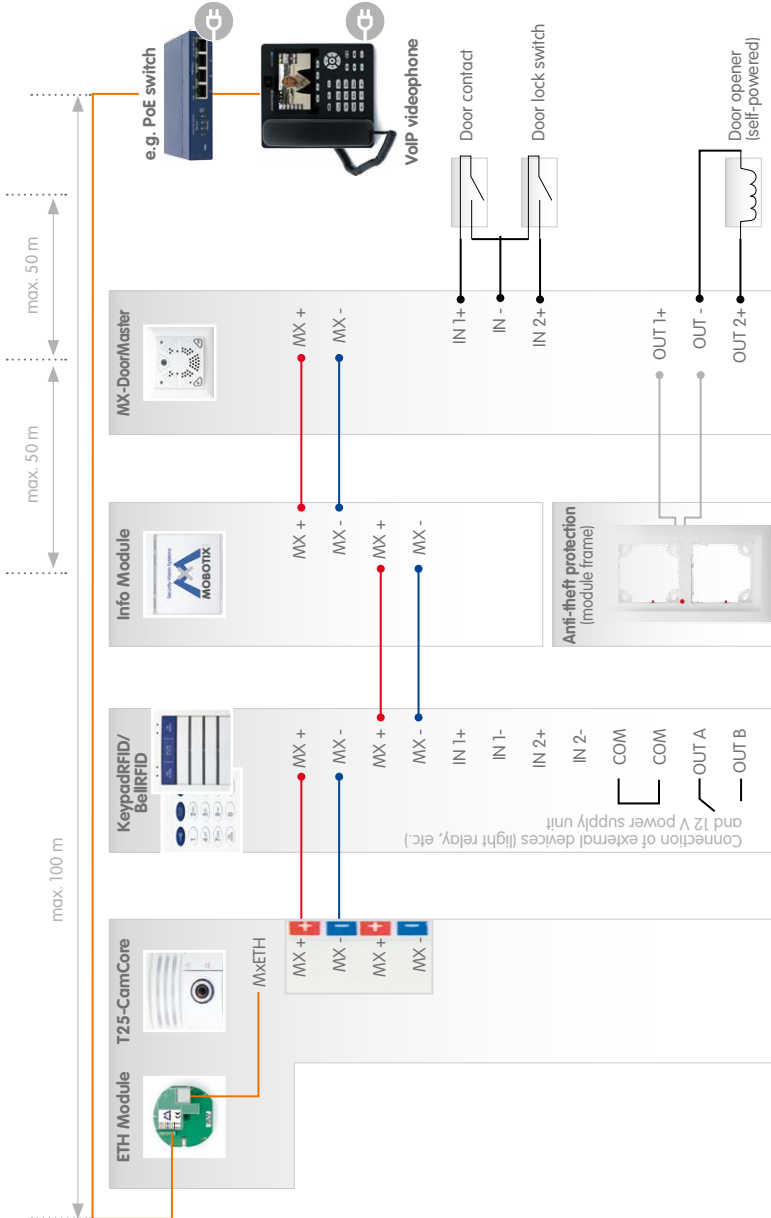

The MX-DoorMaster is always connected to a free MxBus connector of the outdoor station (on the camera module, access or info module)

Modules are connected via the looped-through, two-wire MxBus cable that transfers data and power simultaneously

The module terminal designations are also located directly on the module

2.1.2 Without MX-DoorMaster

When no MX-DoorMaster is used, the **electric door opener or Mediator, including the door and door lock sensors, are connected directly to the access module. In addition, an external 12 V voltage is applied to the door mechanism/Mediator and bridged over to the access module.**

The two cables for the electromagnetic anti-theft protection integrated into the T25 frame (otherwise connected to and powered by the MX-DoorMaster) should be conducted inside the building so that they can be connected to a 12 V supply in case modules are exchanged.

The figure above the connection sections represents the number of cable wires

Black: YSTY 0.8 (recommended) or 0.6 mm

Orange: Ethernet Cat. 5 or higher

The external 12 V supply can be bridged over from the Mediator to the access module to avoid having to use an additional 12 V cable to the access module

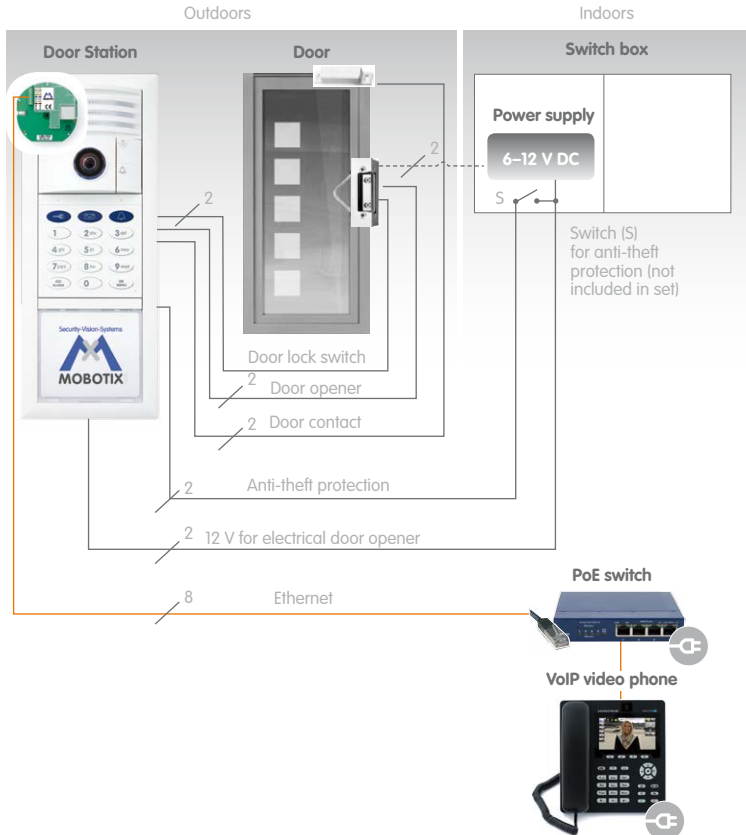

Note

The anti-theft protection is connected to the DC power supply of the door opener via a switch (switch on -> current is flowing -> protection deactivated). If the door opener works with an AC power supply, the anti-theft protection requires its own DC voltage source.

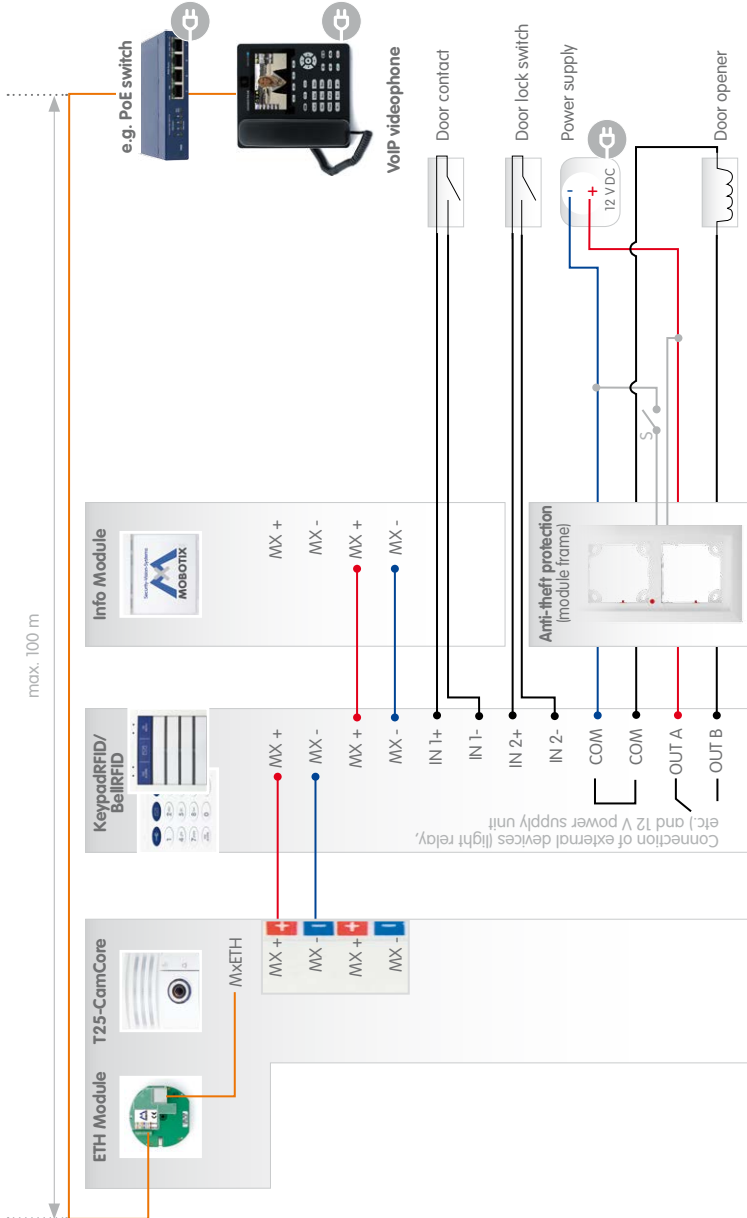

Modules are connected via the looped-through, two-wire MxBus cable that transfers data and power simultaneously (cable included in packaging)

The module terminal designations can be found directly on the module

2.1.3 With Info Module Mx2wire+ and MX-DoorMaster

To be able to use a bell wire already laid in the building to connect the T25 door station to the network and supply it with power, the T25 version with Mx2wire+ technology is required. The two-wire cable must be conducted from the door station info module to a second Mx2wire+ unit inside the building, to which data and power is supplied, for example, via a PoE+ switch.

Installing a MX-DoorMaster with decentralized access code memory makes it impossible to open the door by bypassing the connection cable, and therefore protects against unauthorized access. A battery, kept fully charged via MxBus at all times, supplies power to the electric door opening mechanism (even in the case of a power failure).

The figure above the connection sections represents the number of cable wires

Black: YSTY 0.8 (recommended) or 0.6 mm

Orange: Ethernet Cat. 5 or higher

The external 12 V power supply including a cable from the switch box is required here for an (optional) Mediator

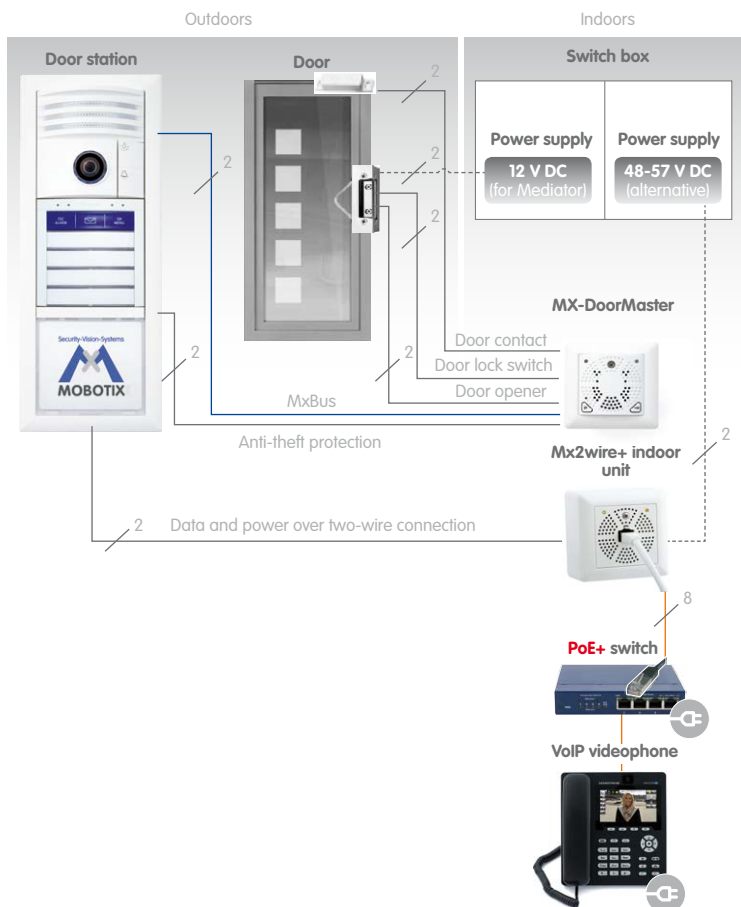

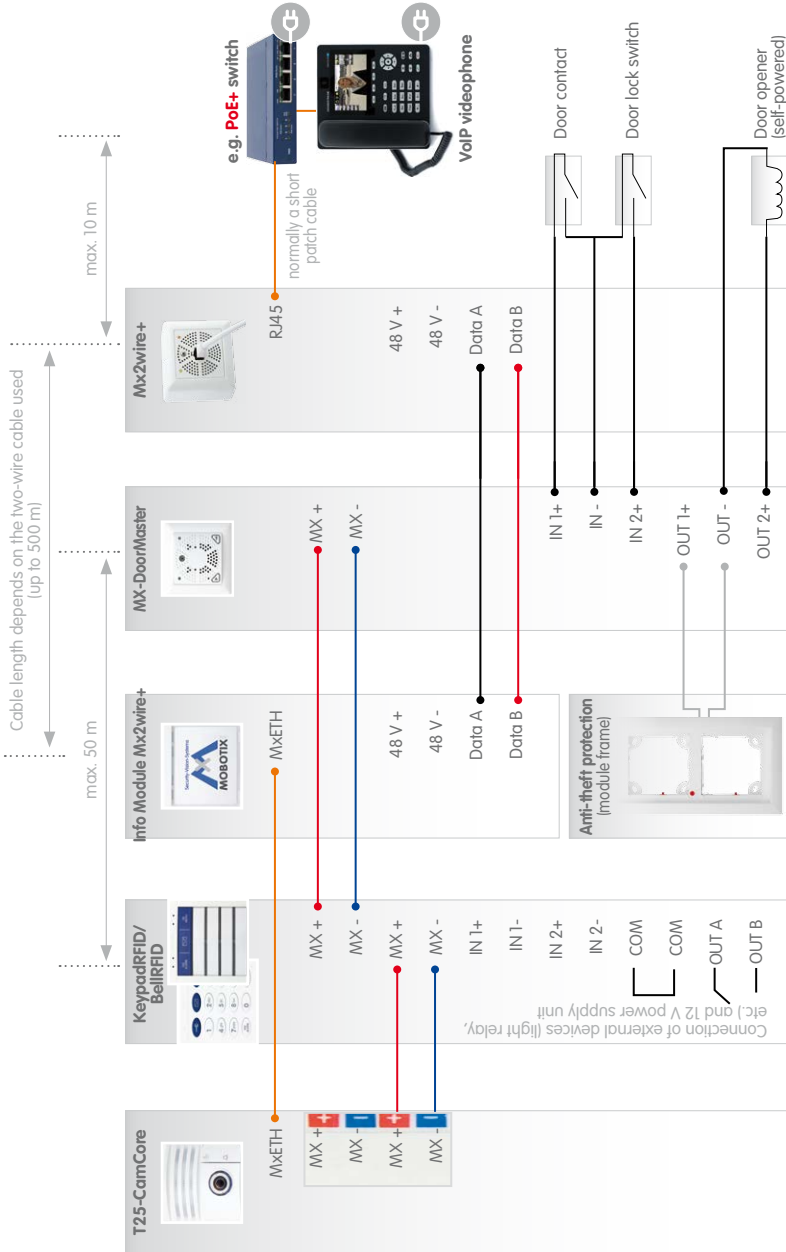

The MX-DoorMaster is always connected to a free MxBus connector of the outdoor station (on the camera module, access or info module)

Modules are connected via the looped-through, two-wire MxBus cable that transfers data and power simultaneously (cable included in packaging)

An Ethernet patch cable is used to connect the Mx2wire+ info module to the camera

The module terminal designations are also located directly on the module

The maximum configuration is specified for these cabling recommendations

2.1.4 Recommendation for Cabling

Depending on the model, the door station and its remote stations require one of the following cabling configurations. Please take note of our cabling recommendations and the maximum cable lengths. Both the network cable and other cables must be stripped at the door station ends.

1 Network cable from the Ethernet terminal board behind the camera module to the switch/injector

- **Recommendation:** Category 5 (Cat 5) Ethernet installation cable or higher; Cat 7 cable is designed for 10 Gbit Ethernet (max. future compatibility)
- **Max. cable length:** 100 m

2 Two wires from the door station to the MX-DoorMaster for the MxBus connector

- **Recommendation:** YSTY (telephone) solid wire, core diameter 0.6 to 0.8 mm
- **Max. cable length:** 50 m

3 Cables from the MX-DoorMaster to the electric door opener, the door contact and the door lock switch

- **Recommendation:** YSTY (telephone) solid wire, core diameter 0.6 to 0.8 mm
- **Max. cable length:** depending on the manufacturer, max. 50 m

4 Two wires from the MX-DoorMaster to an additional power supply (for example, 12 V for Mediator operation)

- **Recommendation:** YSTY (telephone) solid wire, core diameter 0.6 to 0.8 mm
- **Max. cable length:** depending on the manufacturer

5 Two wires from the access module to the 230 V light relay (if present)

- **Recommendation:** YSTY (telephone) solid wire, core diameter 0.6 to 0.8 mm
- **Max. cable length:** depending on the manufacturer

6 Two-wire cable from the Info Module Mx2wire+ to the Mx2wire+ indoor unit (as an alternative to the outdoor station being directly connected to the network)

- **Recommendation:** existing, previously laid bell wire (core diameter 0.6 to 0.8 mm)
- **Max. cable length:** 200 m (JY, A2Y, YR), 300 m (NY), 500 m (Cat 7)

7 Two wires from the door station to the MX-DoorMaster for connecting the MOBOTIX anti-theft protection (for unlocking when exchanging modules)

- **Recommendation:** black two-wire cable already fitted to the frame, possibly extended with YSTY (telephone) solid wire, core diameter 0.6 to 0.8 mm
- **Max. cable length:** 50 m

The supplied patch cable is used to connect the Info Module Mx2wire+ to the camera

NY: installation cable (not live)

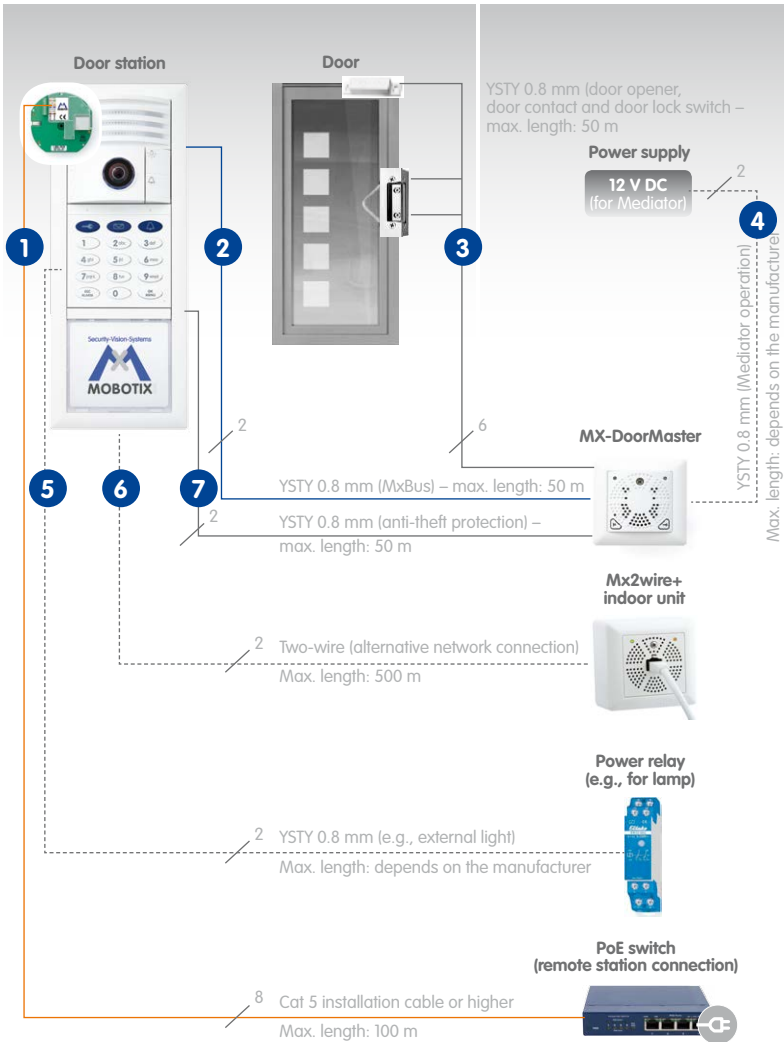

2.1.5 Installation Tip: Replacing an Existing Doorbell by a T25

The MOBOTIX IP Video Door Station, in particular the version with integrated Mx2wire+ technology (for network connection with simultaneous power supply via the same two-wire cable), is an ideal retrofit solution that is very easy and quick to install.

The following two installation steps are normally all that is required to replace an existing, simple doorbell with a complete T25 set including a MX-DoorMaster:

Step 1: Connect the T25 Using a Two-Wire Cable

Disconnect the doorbell from power (by disconnecting the bell transformer), then remove it. Connect the wire pair to the Info Module Mx2wire+ (T25 is mounted directly above the cable). This wire pair is conducted directly to the electrical cabinet, from where it is connected to the power supply and remote stations via the Mx2wire+ indoor unit.

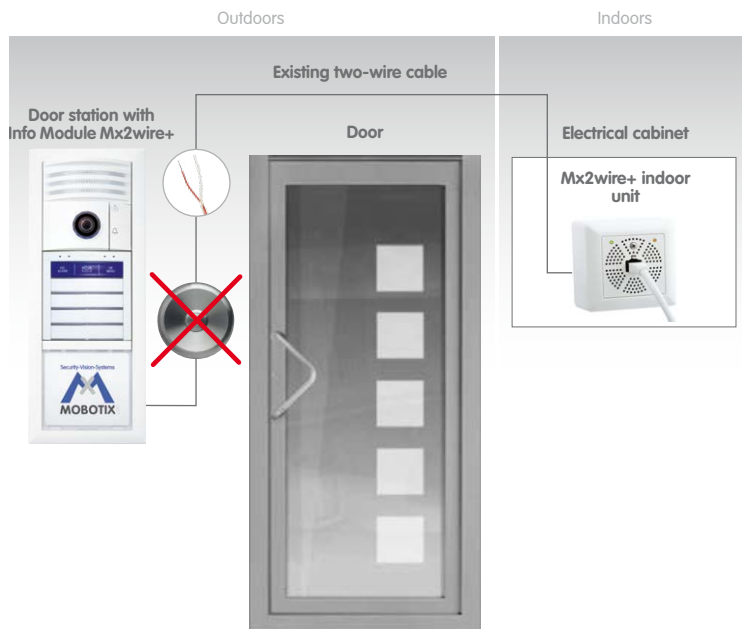

Step 2: Install and Connect the MX-DoorMaster

Install the MX-DoorMaster in a in-wall socket on the wall behind the door station (inside the building). Besides the in-wall socket, only two holes are required for the entire cabling.

Hole A

Use a long drill bit to drill a hole from the door station downwards at an angle, through the brickwork to the in-wall socket of the MX-DoorMaster on the interior wall surface. Insert a 4-wire cable for MxBus and the anti-theft protection (see *Section 2.1.4, «Recommendation for Cabling»*).

Hole B

Use a shorter drill bit to drill a hole through the brickwork from the door lock/ door opener to the in-wall socket of the MX-DoorMaster. Feed the connectors for the door opener, door contact and door lock switch through this hole (see *Section 2.5, «Installing the MX-DoorMaster»*).

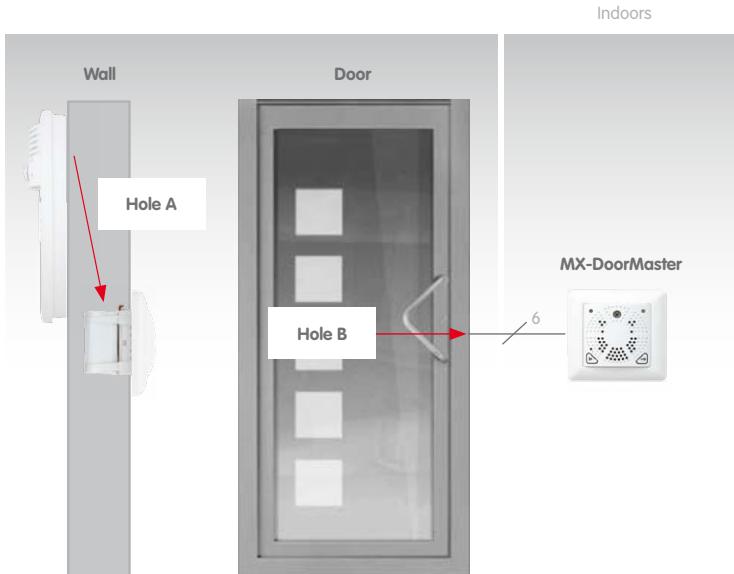

Note

Please contact a specialist (e.g. a locksmith) for the installation and selection of any components that may be required (door opener, magnetic sensors). Door openers and door contacts are available as accessories from other suppliers (e.g. www.assaabloy.com).

2.2 Remote Stations and Network Connection

2.2.1 Notes on Cable Lengths and Power Supply

The T25 door station can only be powered using the Ethernet port of the door camera. A MOBOTIX PoE adapter (MX-NPA-PoE) or other similar, high-quality PoE product conforming to IEEE 802.3af is required to supply the T25 with power (PoE switch). A PoE+ switch (IEEE 802.3at) or a 48 V power supply unit can be used to supply power to the T25 version with Mx2wire+ technology.

The **maximum length** of the network cable for power supply over an Ethernet cable is **100 m**.

Make sure that you only connect the door station or Mx2wire+ indoor unit to switches or routers that support the 10/100 Mbps network interface. Check the LED activity of the corresponding port at the switch or router.

2.2.2 Direct Connection of One Remote Station

If the door station is to be connected for operation to one remote station only (computer with MxEasy or VoIP videophone), MOBOTIX recommends using a MOBOTIX PoE adapter (MX-NPA-PoE) to supply power to the door station. Connect the devices as shown in the following connection diagram:

Connection Using a MOBOTIX PoE Adapter

The MOBOTIX PoE adapter (MX-NPA-PoE-SET) features a crossover function for direct computer connection, and can either be connected to the mains supply or to other voltage sources (12-57 V)

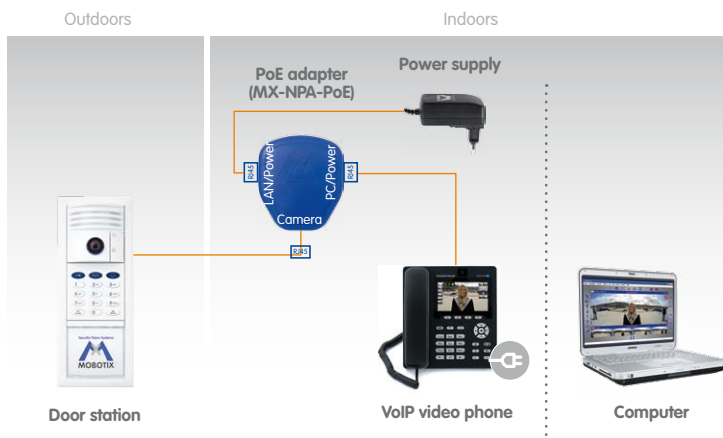

Note

The Grandstream videophone has two ETH connectors, and it can alternatively be connected wirelessly to a network using a WLAN stick (USB port).

2.2.3 Network Connection with Multiple Remote Stations

If the door station is to be connected for operation with multiple remote stations (computers with MxEasy or VoIP videophones) in an existing network (for example, via an Internet box), MOBOTIX again recommends using a MOBOTIX PoE adapter (MX-NPA-PoE) or a switch with multiple ports to supply power to the door station. Connect the devices as shown in the following connection diagram:

Connection Using a PoE Switch



If multiple PoE-supplied end devices (such as several IP cameras) are to be operated, you should consider using a PoE switch

Connection with MOBOTIX PoE Adapter

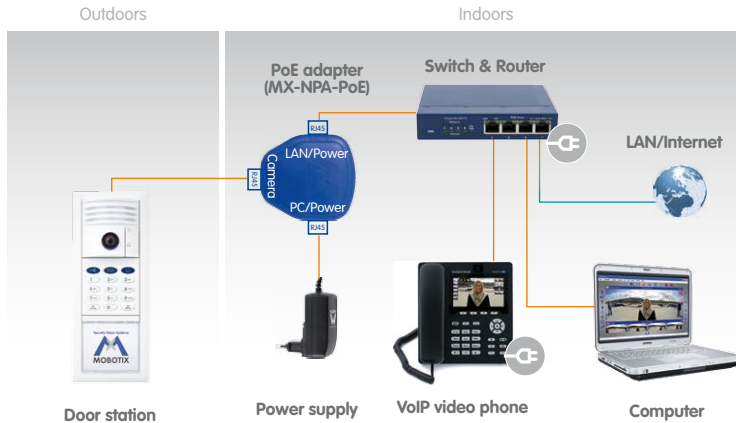

The T25 (with additional PoE power supply, for example, using the MOBOTIX PoE adapter) and its remote stations can also be connected to an existing WLAN router with integrated switch function (DSL box)

Connection with Mx2wire+ and Optional 48 V Power Supply

Note

For a door station with integrated Mx2wire+ technology, an external voltage source (48 V DC) - connected via two wires directly to one of the two Info Module Mx2wire+ units (info module or indoor unit) - can also be used to supply power via the network cable.

An existing DSL box can also be used to connect the Mx2wire+ indoor unit instead of a switch

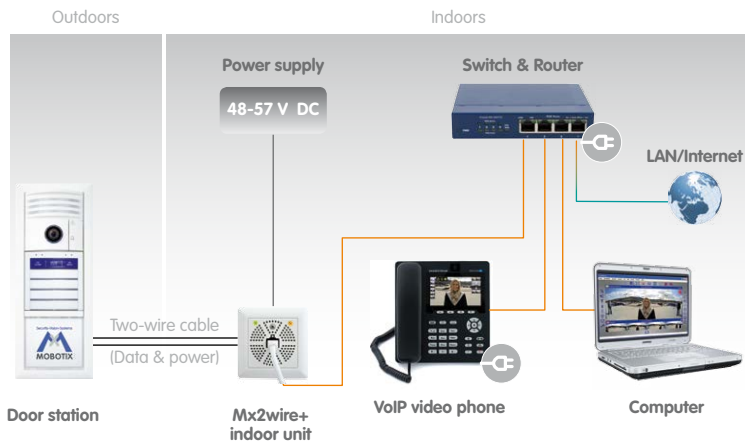

Connection with Mx2wire+ and PoE+ Switch

Although a PoE+ switch complies with the IEEE 802.3at standard, using a 48 V unit to supply power is normally the more economical option if only one end device powered via PoE+ is to be operated

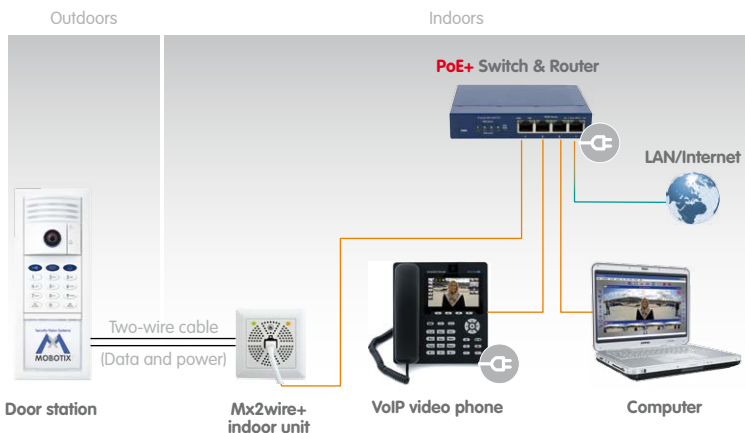

Connecting Multiple T25 Door Stations

In general, a (PoE) switch can be used to connect several T25 door stations to the same remote stations.

However, only one T25 can be connected to a MX-DoorMaster.

Each transponder card can be programmed in such a way that it can be used on all the existing T25 door stations for opening the door.

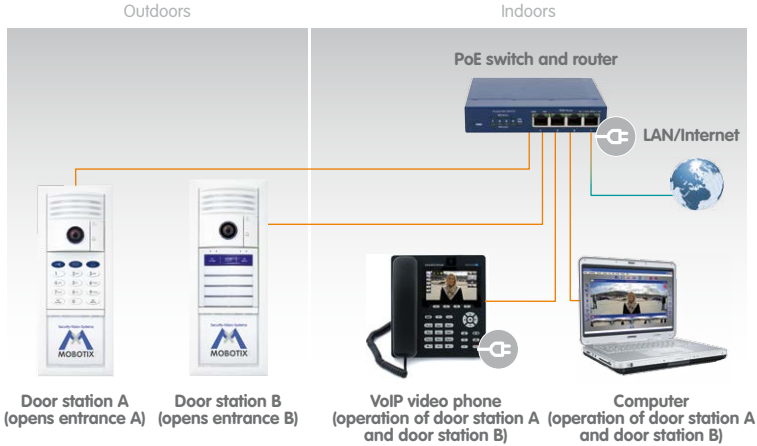

2.3 Mounting the Frame and Housing

A complete T25 door station system includes components that are mounted next to the entrance door, which means they are usually installed outdoors, as well as components such as the MX-DoorMaster, remote stations and power supplies that are installed inside a building.

Please note that only the T25 camera, access module and info module are suitable for outdoor installation (IP65, -30 to +50°C/-22 to 122°F). The modules will only be weather-proof if they have been installed correctly using matching MOBOTIX housings and frames.

2.3.1 Determining the Installation Position

Before installing the door station, you need to decide exactly where to install it. In addition to being mounted vertically (most popular installation option), the door station can also be mounted horizontally.

Hint:

To capture good-quality images at night as well, fit an outdoor light approximately 1 m above the door station (with integrated motion sensor)



Vertical installation



Horizontal installation

In a vertical layout, the camera module T25-CamCore is normally positioned right at the top. The access module is located directly underneath, followed by the info module.

Note

Position the housing directly above the cables that come out of the wall (network, two-wire cables). None of the connection cables should remain visible, as this would make them vulnerable to manipulation.

To ensure ease of use, the system should be installed to accommodate people of different heights. The height from the ground to the upper edge of the frame should be at least 1.60 m.



Unlike conventional door cameras, the T25-CamCore with its 180° image angle is also able to record visitors when they are NOT standing directly in front of the lens. This means that the door station can be mounted quite flexibly, which is particularly useful with wide doors.

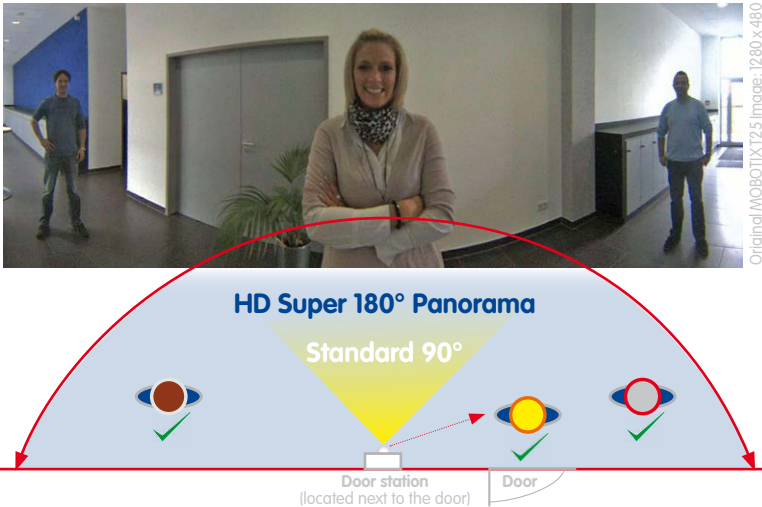

The installation can be on-wall, in-wall or using a cavity socket. MOBOTIX provides two different types of housing for these installation methods. The modules and the frame fitted to the housing are suitable for all installation options.

2.3.2 Inserting the Cables

On-Wall Housing

The housing has cable guides made of elastic rubber to ensure the cable entry points are waterproof.

Use only one cable guide for each cable. Pierce the cable guide you require using a screwdriver or other similar tool and feed the cable into the housing. If the cable is multi-wire, separate the individual wires once the cable is in the housing.

Hint:

Do not open the cable guides up too wide (for example, if you are using a cutter), as cables fed inside the housing must be tightly enclosed (to ensure a tight gasket)

Pierce required guide holes, e.g. with screw driver



Guide cable through hole (one cable per inlet)

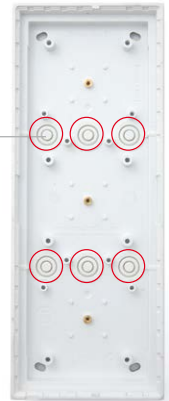

In-Wall and Cavity Housing

The insert prevents the in-wall housing from getting dirty and being deformed during installation in a wall; it must be removed and then positioned again when preparing the cables

Remove the insert and use a screwdriver or similar tool to **pierce through** all the openings on the rear or on sides required for **inserting cables**. As the housing is embedded in the brickwork, this usually makes for a tight gasket. If in doubt, or when using a cavity housing, you should additionally seal off the cable guides with silicone.

Pierce required guide holes

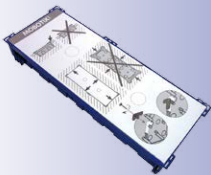
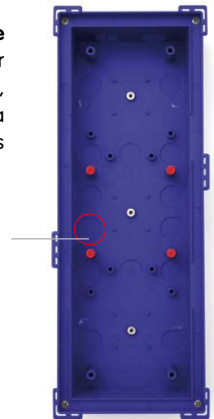

Important: Pay Attention to the Position of the Cables

When installing the door station, make sure that all the required cables (network, MxBus, anti-theft protection and so on) are laid in such a way that they protrude from the wall directly below the housing openings provided.

This particularly applies to the on-wall housing that has up to six cable guides (triple frame). Only one cable (multi-wire cables may be used) should be inserted into each cable guide. The cables should be long enough so that sufficient cable reserves remain to allow easy cabling within the housing (see *Section 2.3.4, «Cabling in the On-Wall Housing»*).

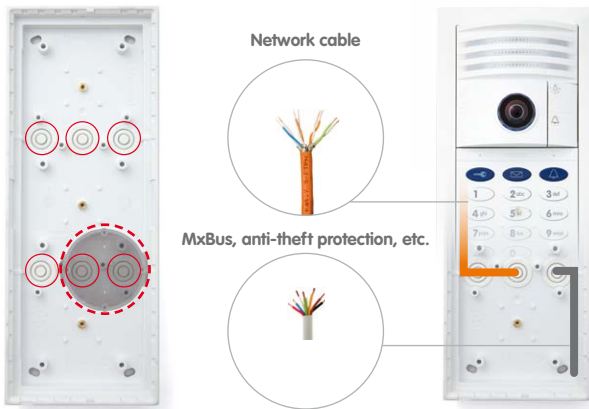

Notes

- Position the housing in the center above the cables
- Only use one cable in each cable guide
- Make sure sufficient cable reserves are provided
- Hint: If longer cable reserves are required, you can mount an additional in-wall socket underneath the on-wall housing (see the dashed line in the figure above).

2.3.3 Attaching the Housing

On-Wall (Fig. Triple Housing)

Drill the four holes and insert the screw anchors (drilling template is included). Ensure that the 'Oben/Top' label points upwards (applies to horizontal and vertical installation). Attach the on-wall housing using four Torx screws and the supplied Torx wrench.



Horizontal installation



Vertical installation

The required installation opening has the following dimensions (width x height):

Single housing: 117 x 129 mm

Double housing: 117 x 218 mm

Triple housing: 117 x 318 mm

Permissible wall thickness

min. 7 mm/max. 27 mm



7-27 mm

Cavity (Fig. Triple Housing)

When installing the housing in a cavity wall, tighten the cross-head screws embedded in the housing corners until the four retaining wings swing out and clamp the housing tightly to the cavity wall.

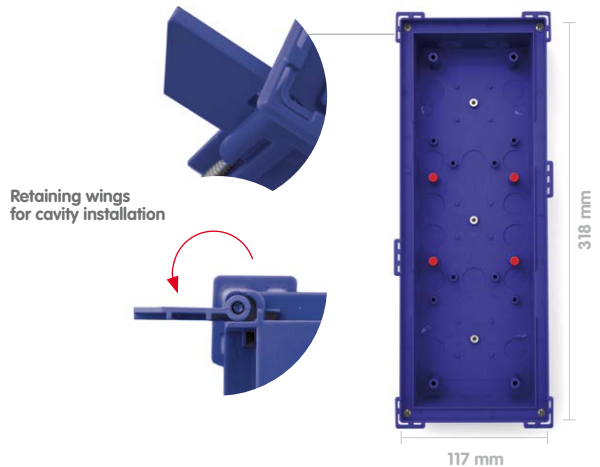

In-Wall (Fig. Triple Housing)

Connect the housing with the subsurface so that the bars fitted to the edge are still visible. The required opening should be 116 x 318 mm. Turn the housing over and use it as a template to mark the hole.

Dimensions for installation opening (W x H x D):

- Single housing: 117 x 129 x at least 52 mm
- Double housing: 117 x 218 x at least 52 mm
- Triple housing: 117 x 318 x at least 52 mm



Hint: Turn the in-wall socket over and use it as a template to mark the hole

Leading edge of housing flush with wall



Caution

Make sure to install the in-wall housing carefully **using the inserted protective cardboard** so that it is not deformed by any pressure from the surrounding material. Otherwise the frame may not be installed properly and may not be sealed against the weather.

To prevent cement or plaster from soiling the inside of the housing, insert the supplied **protective cardboard again before installing the housing in the subsurface of the wall**. After you have secured the in-wall housing, you can easily remove the protective cardboard by pushing through the pre-punched opening and simply pulling out the cardboard.

Pierce opening hole and pull through cardboard

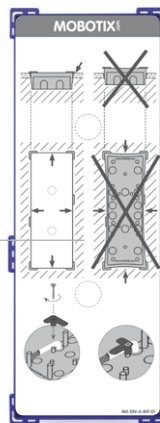

2.3.4 Cabling in the On-Wall Housing

To prevent cables from being damaged when you mount the frame or the T25 modules, make sure that the cables are routed correctly. Please refer to the example cabling shown in the figure below. The packaging material contains four blue cable binders that can be secured to eight designated cable receptacles using screws (**recommendation: Phillips PH 2x100**).

Several cable binders are included in the delivery kit



Mounting points for cable binders (8x, marked yellow)

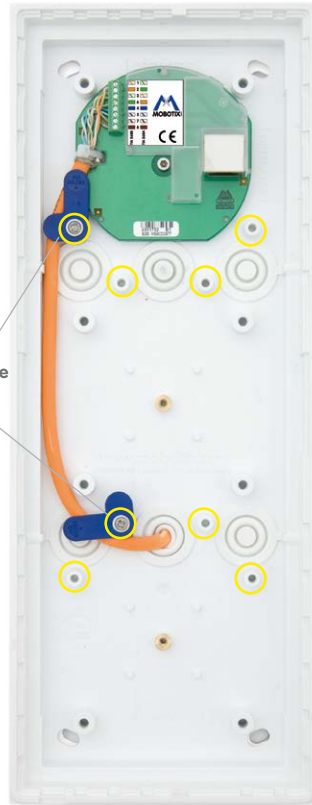

The T25 housing (on-wall/in-wall) provides sufficient space for cable reserves (see the blue dashed line in the figure).

The red areas are 'off-limits areas'. No cables should be placed in this area (risk of damage to cables when module is mounted).

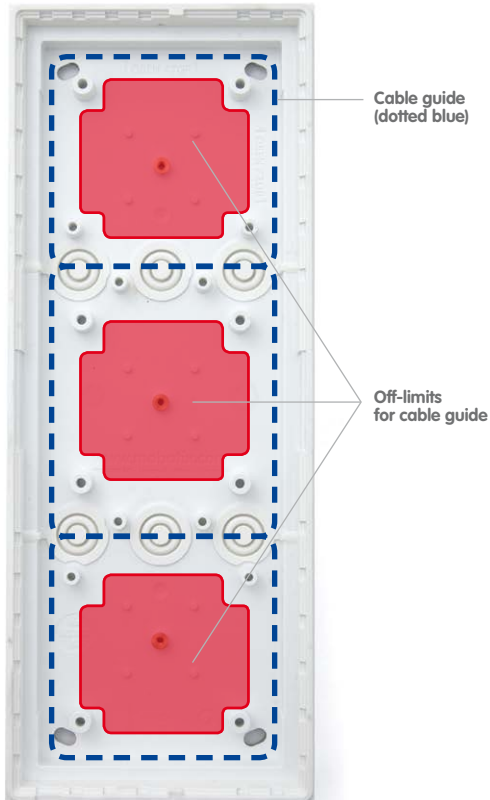

The in-wall housing provides sufficient space - there are no off-limits areas



2.3.5 Mounting the Terminal Board and Fitting the Network Cable

Mounting the Ethernet Terminal Board

Screw the board into the housing (flattened side is at the bottom). **The terminal board must be placed behind the camera module.** This step is not necessary for the T25 version with Mx2wire+ technology (two-wire cable replaces Ethernet cable), as an Ethernet terminal board is not required.



For connecting external devices, an expanded terminal board (IO Module) can be mounted in place of the Ethernet terminal board (see Section 2.7.2)



Attachment of board for vertical and horizontal installation



Stripping and Fitting the Network Cable

The Ethernet terminal board provides a link from the network installation cable to the special patch cable of the camera module mounted directly above.

Connect the eight wires of the installation cable (with stripped ends) to the corresponding contacts on the terminal board in accordance with the sticker (**fig. standardized color coding according to TIA-568B**). Fasten the network cable so that its shielding rests on the terminal board contact field (using the enclosed cable tie).

Follow these measurements when stripping the cable

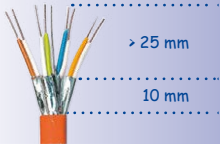

Check whether the network cable at the other end (e.g., PoE switch) is wired according to 568A or 568B (see sticker)

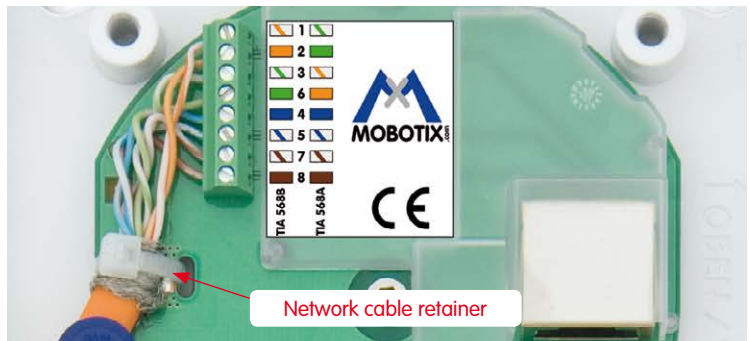

2.3.6 Applying the Gasket

Remove the protection film and stick the supplied gasket all the way round the inner housing frame, ensuring it fits exactly and taking care not to leave any gaps.

Use a pair of scissors to remove any surplus material. Please ensure that the adhesive surface is clean, dry and free of grease.

On-Wall Housing

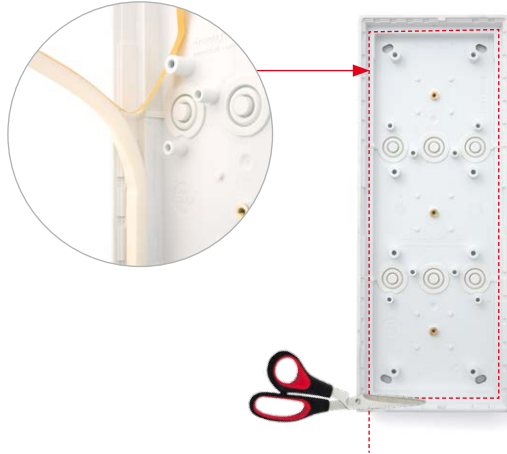

Stick the gasket to the inner frame as shown in the figure

In-Wall and Cavity Housing

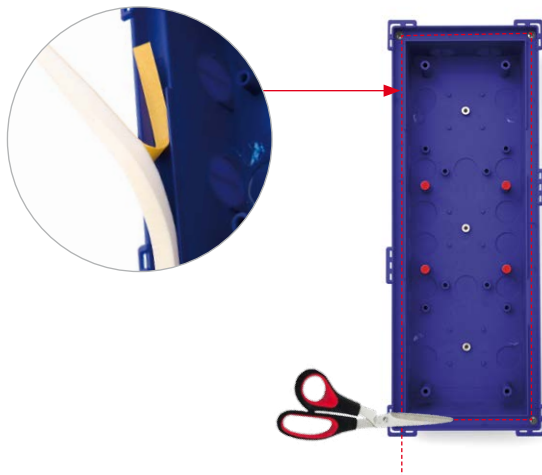

Stick the gasket to the inner frame as shown in the figure

2.3.7 Attaching the Frame and Connecting the Theft Protection

Before the T25 modules can be clicked into the frame, you must screw the frame onto the housing (**recommendation: cross slot PH 2x100**) and lay the black anti-theft protection cable to the inside of the building according to your selected connection option, for example, to the MX-DoorMaster (you may also need to extend the cable). When you attach the frame, make sure that the two openings for the special MOBOTIX key - which is used to remove the door station modules - are located either on the bottom left (vertical mount) or on the bottom right (horizontal mount), and that the maximum torque for the frame screws is not exceeded.

On-Wall (Fig. Triple Housing)

Frame alignment for vertical and horizontal mounting (red arrow points to the keyhole)

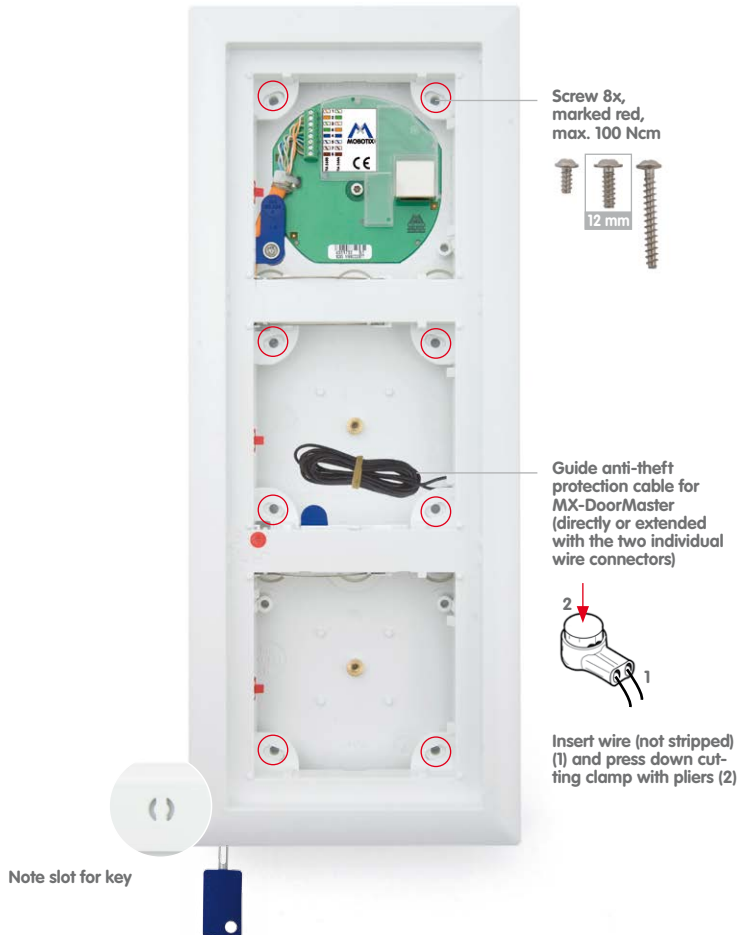

Cavity and In-Wall (Fig. Triple Housing)

Please note that in this case the module frame may only be screwed onto the four outermost positions on the housing (max. torque: 40 Ncm).

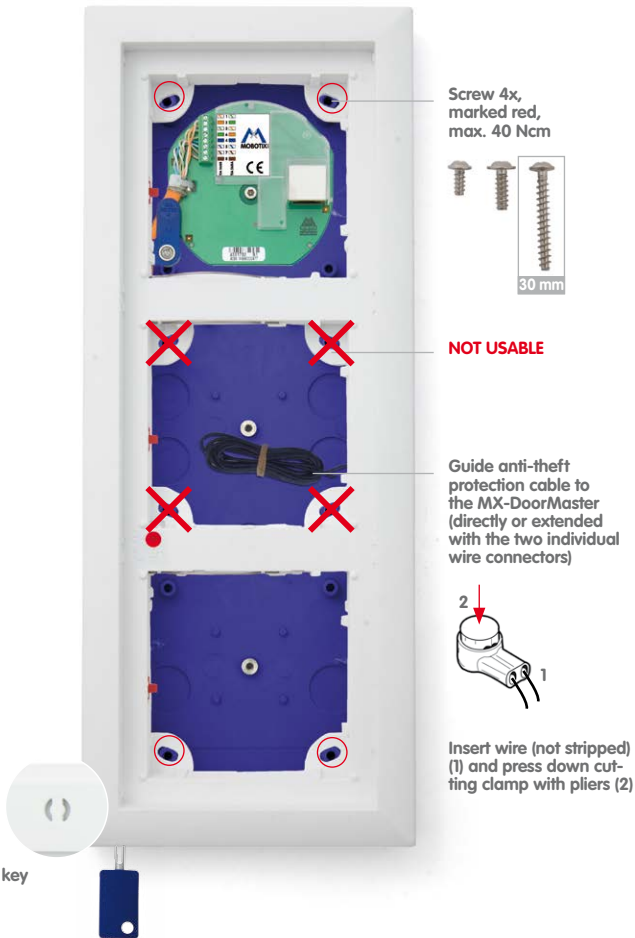

Frame alignment for vertical and horizontal mounting (red arrow points to the keyhole)

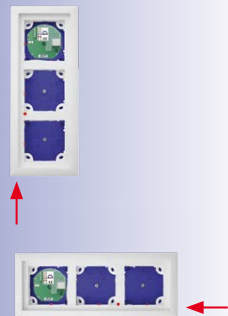

2.3.8 Mechanical Theft-Protection Lock

In the default configuration of the door station, anti-theft protection is **not activated** in the frame. This allows modules that have already been integrated to be removed again during the installation, just using the special key that has been supplied.

Insert the key into the opening provided and apply light pressure. The red retaining collars on the left or lower side of the frame (depending on whether the frame is mounted vertically or horizontally) loosen and release the modules.

Special key



Notes

To activate the mechanical anti-theft protection lock, the module above the **red rotary button** (triple frame: center module, double frame: upper/left module) must be released from the frame.

Important: After the installation, check the wiring (see *Section 2.8.1*) and only then activate the anti-theft protection lock.



Activating the Theft-Protection Lock

Use a screwdriver to turn the red rotary button inside the frame 90 degrees clockwise. When anti-theft protection is activated, the arrow points to the **'closed lock' symbol**.



In this position, using the special key alone to release the modules from the frame is not possible.

Deactivating the Theft-Protection Lock

Turn the red rotary button so that the arrow points to the **'opened lock' symbol**.



In this position, you can use the special key alone to release the modules from the frame.

2.4 Installing the T25 Modules

Caution

Beware of short circuits: When you install the modules, the MxBus cable should not be live, which means that the network cable should still be disconnected from the PoE switch.



2.4.1 Installing the T25-CamCore Camera Module

Standard Network Connection

The Ethernet terminal board is used to connect the door station for the T25 version without Mx2wire+ technology. It connects the short, pre-installed camera patch cable with the eight split-out wires of the network installation cable (for installation, see *Section 2.3.5, «Mounting the Terminal Board and Fitting the Network Cable»*).

1. Ensure that the gasket is fitted to the camera module.



2. Connect the supplied **MxBus cable to the push terminal on the rear wall of the camera**. Remove approximately 5 mm of insulation from the cable ends and push into the terminal.

- **Red wire to + terminal**
- **Blue wire to - terminal**



Note

To connect the MxBus cable of the **MX-DoorMaster**, the two free MxBus terminals of the camera module can be used as an alternative to the MxBus terminals on the access or info module (see *Section 2.5, «Installing the MX-DoorMaster»*).



Do **not** swap the + and - wires

When using a different-colored cable, make sure the correct polarity is routed



3. Guide the **MxBus cable** (to be shortened accordingly) into the housing and under the frame so that it can be easily connected to the access module later on. Insert the pre-installed camera module **patch cable** into the RJ45 port on the terminal board.

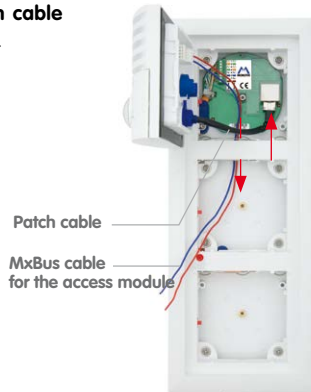

4. First of all, insert the **right side of the module into the frame** and then press firmly on the **left side**, until the module audibly **clicks** into place.



Pay attention to the off-limits areas for cables reserves (see Section 2.3.4)

With horizontal mounting, the modules must first be positioned **at the top** and then pressed downwards firmly

Control click: If you do not hear a click, this means that the module is not properly locked into place. In this case, repeat the last steps, making sure that no cable or foreign object in the housing is preventing the module from properly clicking into place.

Network Connection Using Mx2wire+ Technology

An Ethernet terminal board is not required for the T25 door station with Mx2wire+ technology. Instead, the camera module is connected to the Info Module Mx2wire+ via a MOBOTIX patch cable.

1. Ensure that the **gasket** is fitted to the camera module.



2. **Remove** the **pre-installed camera module patch cable** and instead insert the supplied, **longer patch cable** into the camera housing. Make sure that the blue rubber sealing ring is in the correct final position.

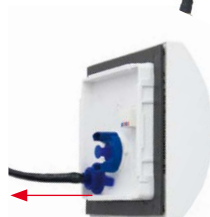

Attach the longer patch cable for the Info Module Mx2wire+ info module



3. Feed the **MxBus two-wire cable** from the camera (installation as described in *Section 2.4.1*) together with the newly fitted **patch cable** into the housing and under the frame, so that the MxBus cable can be fastened to the access module board and the patch cable to the info module.



4. First of all, insert the **right side of the module into the frame** and then press firmly on the **left side**, until the module audibly **clicks** into place.



Control click: If you do not hear a click, this means that the module is not properly locked into place. In this case, repeat the last steps, making sure that no cable or foreign object in the housing is preventing the module from properly clicking into place.



Access Module BellRFID

2.4.2 Preparing the BellRFID Access Module

If the installation of the IP-Video-Türstation with BellRFID is not followed by the initial operation right away, MOBOTIX recommends to remove the keypad insert and to insert the button set before starting the installation. This way, the soft rubber surface of the BellRFID base module is well protected until the module is brought into service (bell buttons are then replaced by the keypad insert). Note that the base module is weatherproof even without the bell buttons.

For additional information on installing and removing the button set, see *Section 2.4.7, «Removing, Exchanging and Modifying Modules»*.

1. Label the name plates

In order to avoid having to remove the module and install it again, you should insert the proper name plates before starting the initial operation. Use our free-of-charge printing service on www.mobotix.com in the **Support** section. Or use the supplied name plates made from sturdy specialty paper and write the names using a UV-resistant marker.

2. Insert the name plates

Remove the silicone insert from the button. Recommendation: Take a suitable tool without a sharp blade, cautiously insert it into the slot, gently press inward and lift the tool as shown.



Insert the labeled or printed name plate as shown (the arrows at the side are pointing upwards later on).



Place the silicone insert on top of the name plate, push it into the frame at the top and at the bottom of the center, then push its sides into the frame.

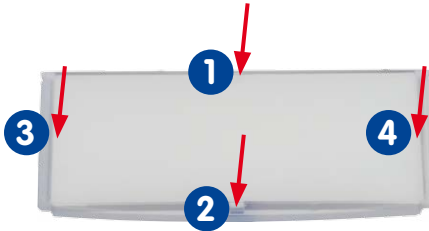

Make sure that the silicone insert properly fits flush into the frame of the bell button as shown to protect the name plate against humidity.

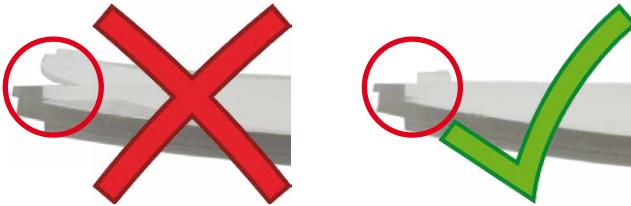

3. Insert the keypad

Place the supplied keypad insert into the base module (push it into the frame at the top, then push the bottom into the module).



2.4.3 Installing the Access Module (KeypadRFID/BellRFID)

Installing the KeypadRFID or BellRFID access modules is identical; the pictures in this section show how to install the KeypadRFID. For more information on these access modules, please refer to the corresponding **Quick Installation** documents (www.mobotix.com > **Support** > **Manuals** > **IP Video Door Station** > **Single Components**):

- **Quick Installation: KeypadRFID**
- **Quick Installation: BellRFID**

Please pay attention to the different system wiring configurations that apply (described in *Section 2.1*), depending on whether or not the MX-DoorMaster and external devices (e.g., lights) are used.

1. Ensure that the **gasket** is fitted to the access module.



Gasket

2. Loosen the **rear cover plate** (using a small screwdriver or similar tool) and remove it. You now have a clear view of the connectors located directly on the access module board.



3. Remove **approximately 5 mm of insulation** from each of the cables to be connected and feed each cable through one of the **wire apertures** in the housing (piercing the rubber membrane).



T25 with KeypadRFID



T25 with BellRFID

4. Connect the two **MxBus cables** that come from the camera module to the **access module board**.

- Red wire to MX + terminal
- Blue wire to MX - terminal



See the circuit overview diagram on the next page

5. Connect **two new MxBus cables to the access module board**, and subsequently connect these to the info module to power its back-lighting. Make sure that the cables are of the required length and that they are routed correctly (does not apply to Info Module Mx2wire+).

- Red wire to MX + terminal
- Blue wire to MX - terminal



Do not swap the polarity of the + and - MxBus wires

Note

The two MxBus cables of the **MX-DoorMaster** can be connected to the access module instead of the camera module, if the info module is connected to the MxBus connector of the T25-CamCore door camera.

If **no lighting function** is required for the info module at all, the MxBus cables do not need to be connected to this module.



6. Connect all the other connection cables (if present):

Standard door opener or relay (for lights etc.):

- First wire to COM terminal
- Second wire to OUT A terminal

External power supply for door opener or power relay (for example, 12 V AC):

- First wire to OUT B terminal
- Second wire to COM terminal

“Door opened/closed” door contact (reed switch):

- First wire to IN 1+ terminal
- Second wire to IN 1- terminal

“Door lock unlocked/locked” door lock switch:

- First wire to IN 2+ terminal
- Second wire to IN 2- terminal

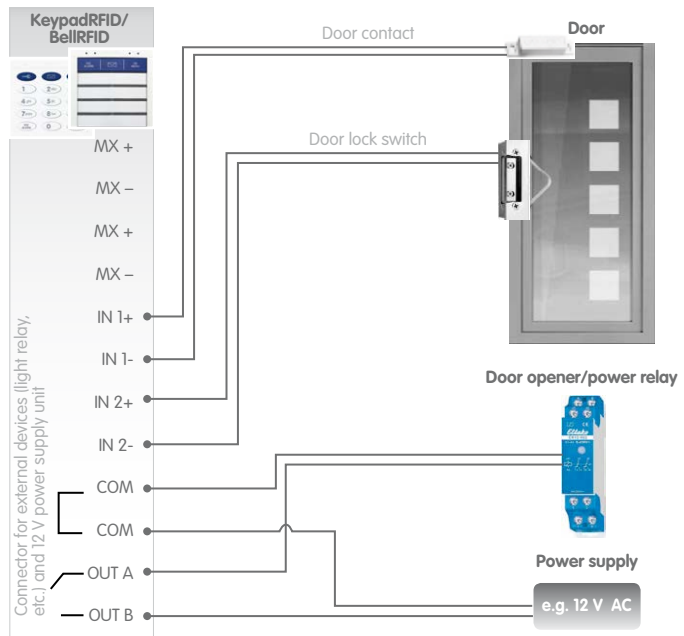

- Put the **cover plate** back on.



- First of all, insert the **right side of the module into the frame**. Then press firmly on the **left side**, until the module audibly **clicks** into place.



Only press firmly on the edge of the access module (not in the middle)

Control click: If you do not hear a click, this means that the module is not properly locked into place. In this case, repeat the last steps, making sure that no cable or foreign object in the housing is preventing the module from properly clicking into place.

Caution

Do not activate the **anti-theft protection lock** until you have checked the wiring (see *Section 2.8.1*). Also test the functionality of the anti-theft protection (see *Section 2.4.7*, «Removing, Exchanging and Modifying Modules»).

2.4.4 Installing the Info Module

The info field in the info module of the T25 door station without Mx2wire+ technology is equipped with permanent LED backlighting supplied via MxBus.

1. Ensure that the **gasket** is fitted to the info module.



2. Loosen the **rear cover plate** (using a small screwdriver or similar tool) and remove it. You now have a clear view of the connectors located directly on the info module board.



3. Remove **approximately 5 mm of insulation** from each of the cables to be connected and feed each cable through one of the **wire apertures** in the housing (piercing the rubber membrane with the cable).



T25 with KeypadRFID

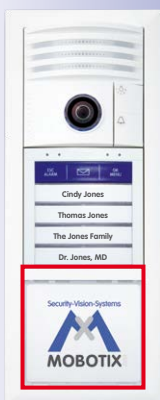

T25 with BellRFID

4. Connect the two **MxBus cables** that come from the access module to the info module board.

- Red wire to MX + terminal
- Blue wire to MX - terminal



As an alternative to the terminals on the access or info module, you can use the two free MxBus terminals of the camera module to connect the MX-DoorMaster (see Section 2.5)

5. Put the **cover plate** back on.



6. First of all, insert the **right side of the module into the frame**. Then press firmly on the **left side**, until the module audibly **clicks** into place.



Always mount the module so that the bar with the **MOBOTIX** lettering is at the top



Control click: If you do not hear a click sound, this means that the module is not properly locked into place. In this case, repeat the last steps, making sure that no cable or foreign object in the housing is preventing the module from properly clicking into place.

2.4.5 Installing the Info Module Mx2wire+

The info module with integrated Mx2wire+ technology is used to connect the door station to the network via a two-wire cable such as a bell wire and has an info field with permanent LED backlighting.

1. Ensure that the **gasket** is fitted to the info module.

Gasket



2. Loosen the **rear cover plate** (using a small screwdriver or similar tool) and remove it. You now have a clear view of the connectors located directly on the info module board.



3. Remove **approximately 5 mm of insulation** from each of the cables to be connected and feed each cable through one of the **wire apertures** in the housing (piercing the rubber membrane with the cable).



4. Connect the **two-wire cable**, which leads to the separate **Info Module Mx2wire+ unit in the building**, to the board.

- First wire to Data 1 terminal
- Second wire to Data 2 terminal

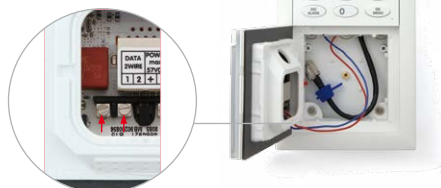

T25 with KeypadRFID

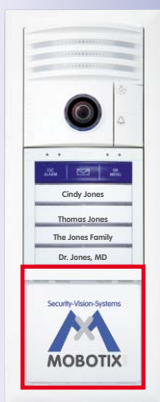

T25 with BellRFID



Mx2wire+ indoor unit (for installation, see Section 2.6)

- 5. Remove the blue **sealing plug** on the module. Feed the **RJ45 connector of the (extended) camera patch cable** into the housing and insert it into the RJ45 port. Make sure that the **rubber sealing ring** on the patch cable is in the correct final position.



- 6. Put the **cover plate** back on.



- 7. First of all, insert the **right side of the module into the frame**. Then press firmly on the **left side**, until the module audibly **clicks** into place.

Control click: If you do not hear a click, this means that the module is not properly mounted. In this case, repeat the last steps, making sure that no cable or foreign object in the housing is preventing the module from properly clicking into place.



Always mount the module so that the bar with the **MOBOTIX** lettering is at the top



2.4.6 Labeling the Info Module

The info module allows you to place a paper label or printer label behind the transparent cover. You can use the enclosed permanent marker to personalize the paper insert by adding your name, contact number, house number and so on.

You will find a PDF template on the MOBOTIX website to help you create your own label. Simply add your personal data to the template and print it onto a sheet of A4 paper. Then simply cut out your 'doorbell label' and insert it into the info module. Before you do this, you will need to remove the info module from the door station frame (see *Section 2.4.7, «Removing, Exchanging and Modifying Modules»*).

Note

To create a doorbell label that goes with a KeypadRFID module, please make sure to familiarize yourself beforehand with how to configure and operate the door station (see *T25-System Manual Part 2*).

Proceed as follows:

1. Make your **personalized doorbell label**. To do this, customize the PDF template (Info_Panel.pdf) provided on the MOBOTIX website (www.mobotix.com).



2. **Loosen the transparent protective cover** on the info module by hand or using a screwdriver, which you position on the side (as shown in red) and use as a lever.



3. Tilt the **protective cover downwards** and remove the silicone mat and paper insert.



- Place your completed doorbell label (B) behind the transparent protective cover (A). Insert the silicone mat (C) so that its smooth side is behind the label.

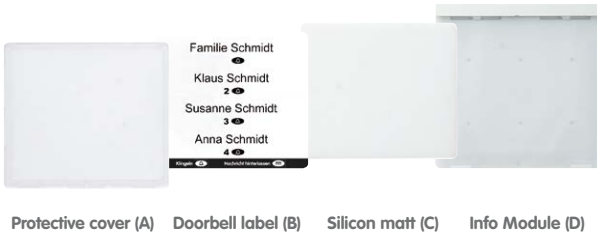

Follow the correct order (from left to right)

- Position the **protective cover at the bottom of the info module (D)** and press the top of the cover until it clicks in place. Now, you can click the info module back into the door station frame.



Info_Panel.pdf (available at www.mobotix.com)

Here are a few examples of doorbell labels that were created using the PDF file template. To open the file requires Adobe Acrobat Reader (free).

Adobe Acrobat Reader: download from www.adobe.com

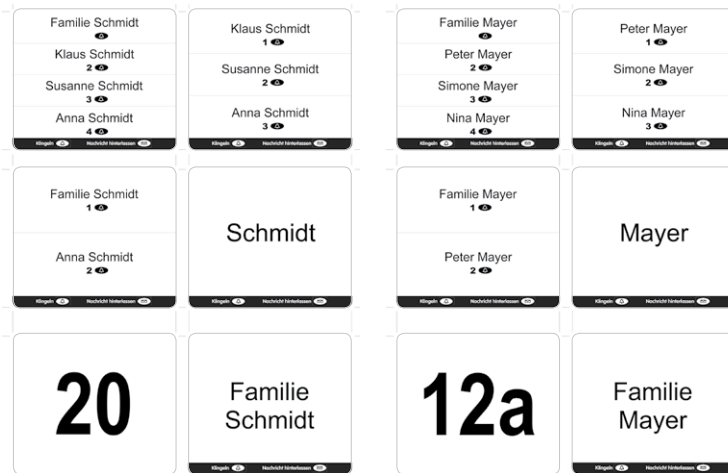

2.4.7 Removing, Exchanging and Modifying Modules

If anti-theft protection has been activated (see *Section 2.3.7*), you will need to switch this off before you can remove and exchange the modules.

1. **Switching off anti-theft protection on the MX-DoorMaster:**

Press both buttons on the MX-DoorMaster at the same time for ten seconds to deactivate the anti-theft protection for 90 seconds (blue LED blinks). After this, the protection will be automatically reactivated.



Hold at the same time until the blue LED flashes

2. **Switching off anti-theft protection when there is no MX-DoorMaster:** Connect the two cables of the anti-theft protection to the 12 V power supply of the electric door opener via a switch. Anti-theft protection is deactivated for as long as the voltage is applied (switch on).

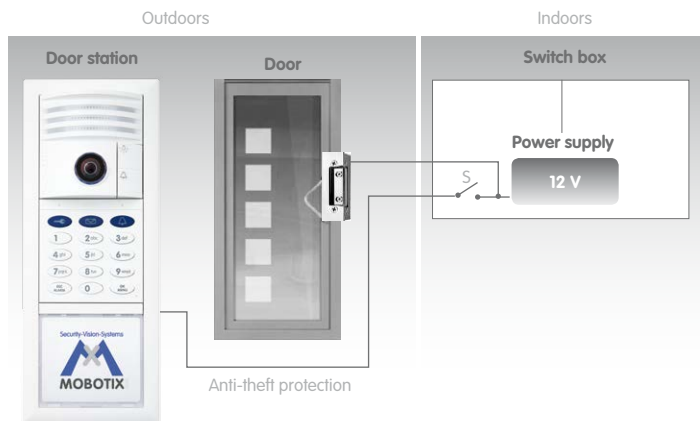

Caution

The anti-theft protection must be disconnected from the voltage again (switch off) **after no more than five minutes** in order to avoid an overload.



- 3. **Removing the modules:** Insert the special MOBOTIX key provided into the split opening on the module frame (bottom left or bottom right, depending on how it has been mounted) and release the modules from the frame by pushing the key in. All the modules in the frame move slightly forward and can be removed. Click (listen for "click" sound) any modules that you do not wish to remove back into place.



The special key is included with the door station



Caution

Make sure that the anti-theft protection has been deactivated before you insert the key, otherwise you risk damaging the frame.



Replacing the Bell Button Set of the BellRFID

If you want to install a different bell button set, you first need to remove the BellRFID module. Next, proceed as outlined in the *Section «Changing the Bell Button Set»* in the *T25-System Manual Part 2*.

Inserting the Modules

Once the bell buttons have been exchanged, proceed as described in the corresponding subsections of *Section 2.4* to re-insert the modules.

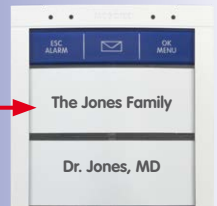

2.5 Installing the MX-DoorMaster

2.5.1 Overview of Connectors

The MX-DoorMaster is connected to the door station via the **MxBus two-wire cable** and the two wires of the **anti-theft protection cable**.

In addition, the four cables of the **door signal contacts** and the two cables of the electrically operated **door opening components (standard door opener, Mediator)** can also be connected to the MX-DoorMaster (see «*Technical Specifications*» in *Section 1.2*).

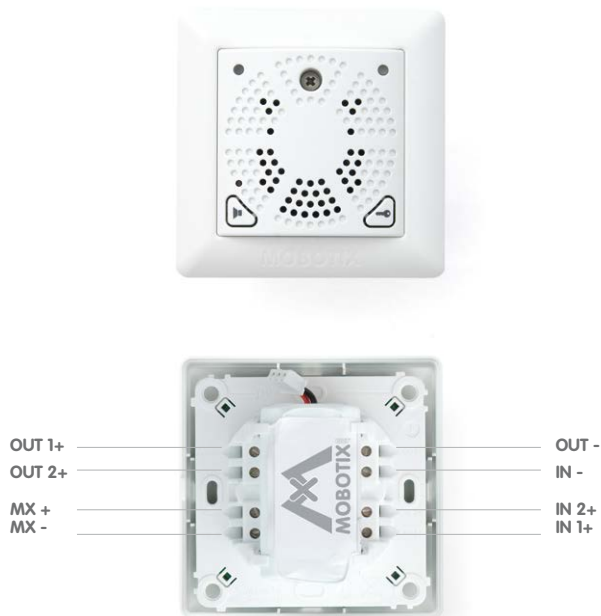

The main function of this innovative device is to control the door opener in a tamper-proof manner and record the status of the door (open, closed, closed and locked). The MX-DoorMaster, with its speaker that can be switched off, also functions as a doorbell. It furthermore allows the door to be opened using a button and controls the anti-theft protection in the T25 housing.

Thanks to its built-in batteries, which are kept fully charged via the MxBus cables, the MX-DoorMaster is able to power both the access module in the outdoor station and a connected door opener for several hours in the case of power failure, therefore ensuring that the door can still be accessed without a key.

Integrated emergency
unlocking function

MX-DoorMaster System Overview

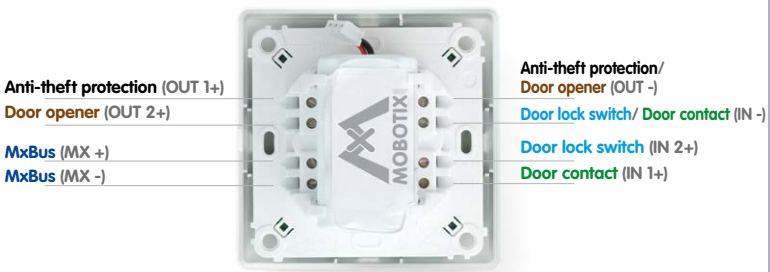
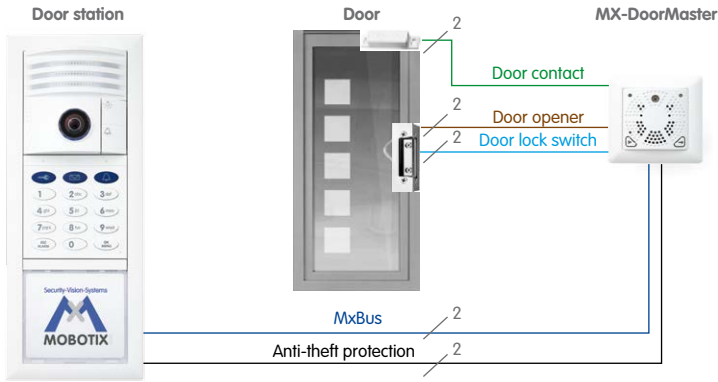

Supported Door Opener Versions

A standard door opener operated with 6 to 12 V AC can be connected directly to the MX-DoorMaster and powered by its integrated battery pack. There is no need to connect an additional power supply unit.

A door opener with an external power supply of up to 24 V AC/DC (max. 1 A) may also be connected, as may the self-locking Mediator door lock.

The MX-DoorMaster must be configured for the selected door opener version (see Section 2.8.2)

2.5.2 Connection Diagrams for Door Opener Versions

Version 1: Power Supply from MX-DoorMaster Battery (Self-Powered)

The MX-DoorMaster's permanently-charged battery pack provides a supply voltage to the door opener and therefore also bridges power failures.

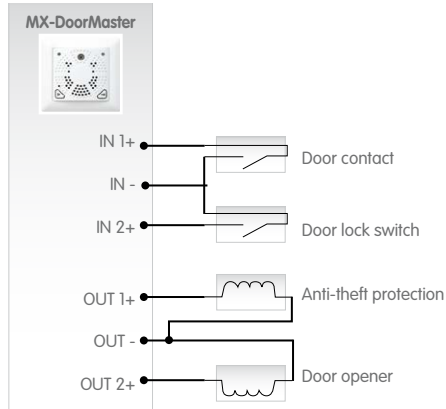

Self-powered (standard version)

Use the enclosed three-wire connector for terminals that are assigned two wires (IN-/OUT-) (insert unstripped wires and press down cutting clamp with pliers)



Version 2: Power Supply from External Power Supply Unit (Internal Relay Function)

The MX-DoorMaster's integrated relay function switches a maximum external voltage of 24 V (SELV, max. 1 A).

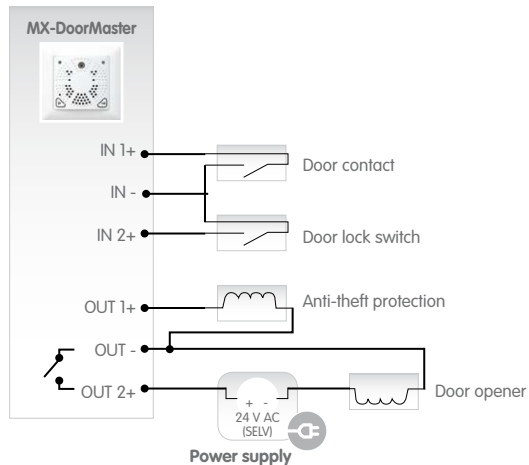

The MX-DoorMaster has an integrated relay function

Version 3: Self-Locking Mediator Door Lock Including UPS via Battery Pack

In this connection option, the MX-DoorMaster's battery pack powers the system in the event of a power failure and allows the door to be opened without a key. In this case however, anti-theft protection must be controlled using an additional switch (to be ordered separately).

In the following diagram, for example, anti-theft protection is used together with a Mediator power supply. The modules can then be released by pressing the switch.

Note

The anti-theft protection must be disconnected from the voltage again after no longer than five minutes (in the example switch 'S' is off) in order to avoid an overload.

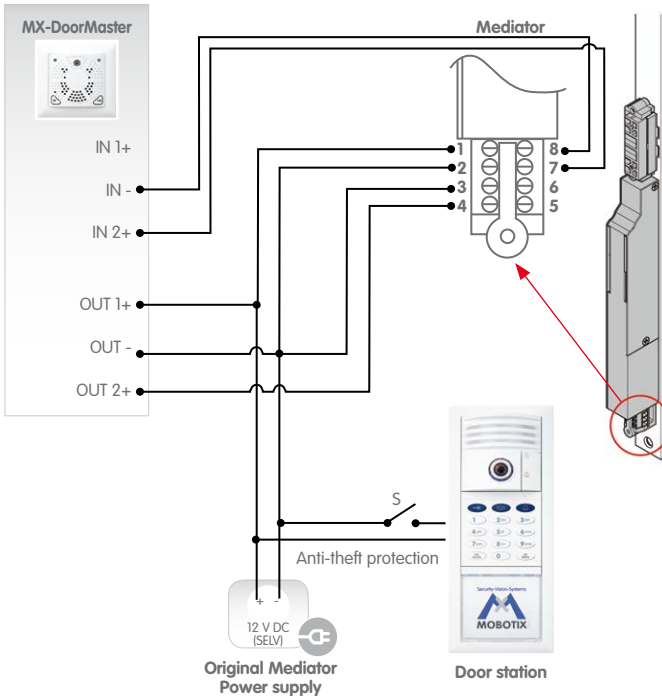

Mediator

Anti-theft protection connection cables are pre-fitted to the frame and can be extended (max. 50 m)

2.5.3 Mounting Instructions

Solid Concrete or Stone Wall

MOBOTIX recommends using a deep in-wall socket (more space for cables). Standard in-wall sockets with a depth of 43 mm are not suitable for the MX-DoorMaster.



Deep in-wall socket (ø 68 mm, 67 mm in depth)

Cavity Wall (e.g. Drywall, 7 mm to 35 mm)

Use the supplied 61 mm-deep cavity socket for the MX-DoorMaster.



Cavity socket (ø 68 mm, 61 mm in depth)

Drill hole for cavity socket: ø 68 mm

Maximum MxBus cable length between MX-DoorMaster and door station: 50 m

Note

MOBOTIX offers two orange cavity sockets of different depths (48 mm and 61 mm). The 61 mm-deep socket is designed for the MX-DoorMaster, and the 48 mm-deep socket is intended for the Mx2wire+ indoor unit.

Determining the Installation Position

The MX-DoorMaster must always be installed indoors protected from weather and moisture. If in doubt, use the normal installation conditions of a standard socket with no cover as a guide. The anti-theft protection connection cables pre-fitted to the frame of the outdoor station do not need to be extended if the MX-DoorMaster is mounted on the same wall behind the outdoor station (next to the entrance door).

Installing the MX-DoorMaster

Preparing the In-Wall Socket (Solid Wall)

An in-wall socket must usually be fitted first. Make sure that the socket you use is as flush with the wall as possible to ensure proper installation. Also make sure that the socket and MX-DoorMaster are aligned correctly.

After connecting the cables, there are **two ways** to attach the door opener board to the in-wall socket:

1. Secure the housing and board **directly to the socket** by fastening two small screws in the a and b positions (see fig.) However, this requires that the socket is properly aligned in the wall. Thanks to the elongated shape of the screw holes, it is possible to make small adjustments to the left and to the right when tightening the screws.

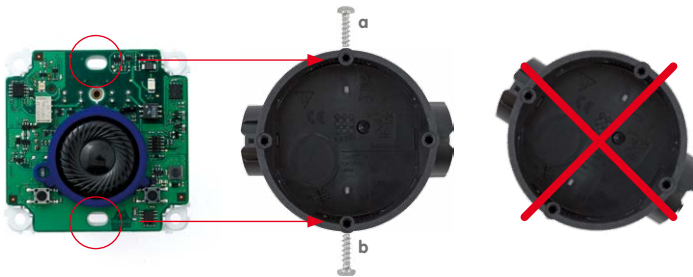

2. Use four or two Torx screws/screw anchors (diagonally opposite one another) to tightly screw the housing and board **to the wall**. We recommend using this procedure if the installed in-wall socket is not properly aligned or is not flush with the wall, or if the MX-DoorMaster could easily be pulled out together with the in-wall socket.

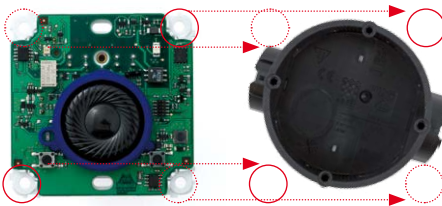

The in-wall socket used must be flush with the wall.



Hint: Use a cavity socket cutter (countersink hole cutter)

When the screws are tightened, the metal claws automatically pop out and clamp the socket to the cavity wall (made of wood or plasterboard, for example)

Preparing the Cavity Socket (Cavity Wall)

The MX-DoorMaster can be mounted to a cavity wall (for example, plasterboard up to a thickness of 35 mm) using either the supplied cavity socket or an existing socket. Push the cavity socket into the prepared drill hole (68 mm) in the cavity wall and secure it by tightening the clamp screws. The metal claws automatically pop out and clamp the socket firmly.

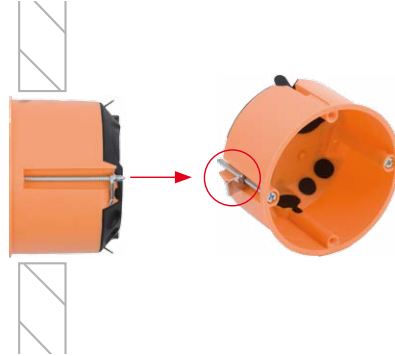

After connecting the cables, secure the housing and board directly to the cavity socket by fastening two small screws in the a and b positions (see fig.) This requires that the socket is properly installed in the wall.

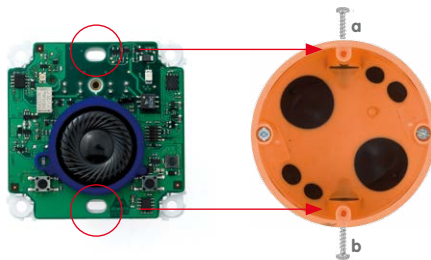

As in the case of the in-wall socket, you can also use four or two screws/screw anchors (diagonally opposite one another) to tightly screw the housing to the wall.

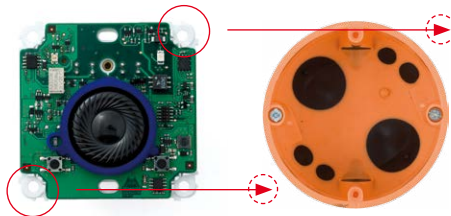

2.5.4 Installation Using Cavity or In-Wall Socket

1. Prepare all the required **cabling and the cavity or in-wall socket**: See previous sections.

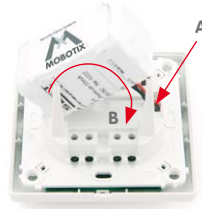

2. Remove the **battery pack**, connect the connector (A), guide the cable under the battery pack and replace the battery pack (B). The red LED indicates that the battery is low.

3. Screw on the **MxBus cable** (coming from the T25 door station):

- Red wire to MX + terminal
- Blue wire to MX - terminal

When extending the MxBus cable, make sure the polarity is correct (+/-).



Remove approximately 5 mm of insulation from all the cables used

4. **Screw on the anti-theft protection** (coming from the T25 door station):

- First wire to OUT 1+ terminal
- Second wire to OUT - terminal

The device still functions properly if the wires are swapped.



5. Screw on the electric **door opener** (coming from the door):

- First wire to OUT 2+ terminal
- Second wire also to OUT - terminal

The device still functions properly if the wires are swapped.



Important: See the connection options in Section 2.4.2

6. Screw on the 'door lock unlocked/locked' **door lock switch** (coming from the door):

- First wire to IN 2+ terminal
- Second wire to IN - terminal

The device still functions properly if the two wires used here (operating contact and changeover contact) are swapped.



7. Screw on the 'door opened/closed' **door contact** (reed switch) coming from the door:

- First wire to IN 1+ terminal
- Second wire also to IN - terminal

The device still functions properly if the two wires used here (operating contact and changeover contact) are swapped.



8. **Remove the front panel and frame:** In order to protect the board, the board is attached to the front panel and frame in the original packaging. To continue with the installation, however, you must first separate the housing and board from the panel and frame. Loosen the screw in the front panel and lift the panel forwards.

Now remove the attached frame from the board. Please note that you will need the stainless steel screw in the front panel again later.



9. **Insert the housing and circuit board into the socket:**

The two cable clamps on the rear of the housing are located at the top. When using a cavity socket, make sure you only use the stainless steel screws provided. Using different (larger) screws could damage the board.



Caution

Electrical systems and equipment may only be installed, modified and maintained by a qualified electrician or under the direction and supervision of a qualified electrician in accordance with the applicable electrical guidelines.



- 10. Attach the frame:** Place the selected frame (concave, convex or flat) onto the board and press down gently until it automatically snaps into place. MOBOTIX is printed on the bottom of the frame.



Select the type of frame required

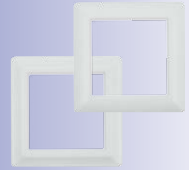

- 11. Insert the panel:** Hook the front panel onto the bottom of the frame, as shown in the figure, and then press it down.



- 12. Screw the panel on tightly:** Secure the front panel using the panel's stainless steel screw.

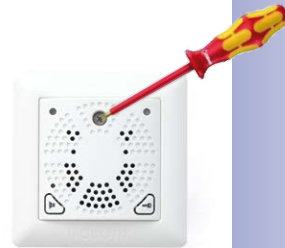

Notes

Make sure not to block the holes in the front panel (air circulation).

Following installation and initial operation, the MX-DoorMaster batteries should be charged continuously for the first 12 hours. This takes place automatically via the PoE-powered T25 door station using the MxBus two-wire cable. During this time, the electric door opening function should not be used (except for a short functional test). This will maximize and extend the battery life of the high-quality NiMH battery (industry standard) to several years at normal use.

When replacing the batteries, always be sure to use original batteries. You can purchase these directly from MOBOTIX or your MOBOTIX partner.

When a battery is almost completely discharged, a functional test can only be carried out after the red LED has gone out (after approximately 15 minutes)



2.6 Installing the Mx2wire+ Indoor Unit

2.6.1 Overview of Mx2wire+ Technology and Connectors

The Mx2wire+ technology that is optionally available with the T25 is used to connect the door station to the network via a simple two-wire cable such as the connection cable of an existing doorbell. An Mx2wire+ set always consists of two devices that communicate with one another: the Info Module Mx2wire+ in the outdoor station and the compact Mx2wire+ indoor unit.

In addition to data, power is also supplied via the two-wire cable to the Info Module Mx2wire+, which (connected to the camera module via a patch cable) becomes a PoE injector for the entire outdoor station and the MX-DoorMaster.

Network Connection and Power Supply (Data and Power)

The Mx2wire+ indoor unit has an RJ45 port and is connected by patch cable to a switch or router, and thus also to the local network and the remote stations. In order for Mx2wire+ to power the T25, a voltage source is required. **There are two ways to achieve this:**

1. Power supply from a PoE+ switch (Class 4, IEEE 802.3at, max. 30 W)

Connection: via patch cable on the Mx2wire+ indoor unit.

With Info Module Mx2wire+

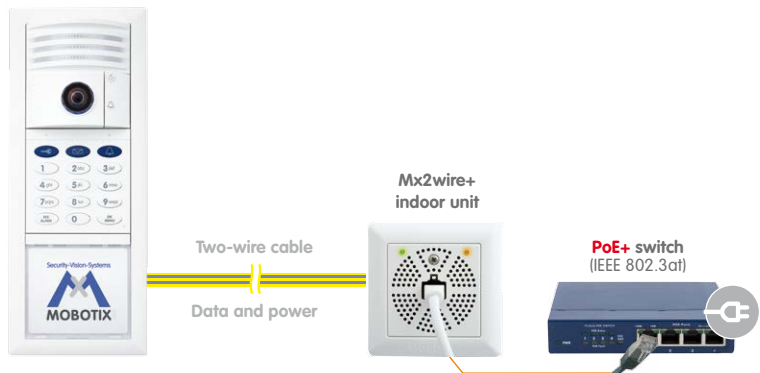

Advantage: The PoE+ switch directly connects the T25 remote stations as well, and depending on the number of available ports, it can also power further PoE devices (door stations, IP cameras).

2. Power supply from an external 48 V DC power supply unit

Connection: via two contact terminals either on the Info Module Mx2wire+ or on the Mx2wire+ indoor unit.

With Info Module Mx2wire+

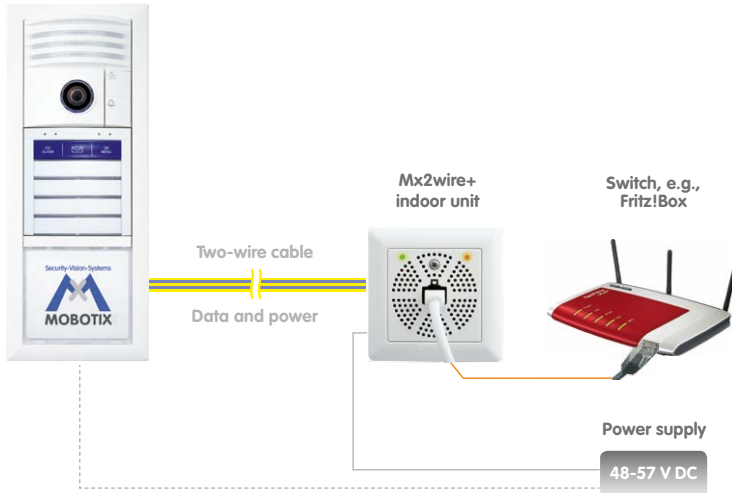

Advantage: flexible voltage connection option and direct connection of a router/switch for connecting remote stations (for example, Fritz!Box WLAN).

Extending the Range

A further advantage of Mx2wire+ is that it allows the range of a connection to be extended considerably using a two-wire cable up to 500 m long (a T25 connection using a network cable is limited to 100 m). For detailed technical information on the T25 version with Mx2wire+ technology, see *Section 1.1.6, «Info Module Mx2wire+ (With Mx2wire+ Indoor Unit)»*.

2.6.2 Mounting Instructions

Mounting Options

In addition to an **on-wall installation** using the supplied surface-mounted socket, you can also choose to install the Mx2wire+ indoor unit using a **standard in-wall socket** or a **cavity socket (for wood or plasterboard, for example)**. Included in the delivery is a cavity socket of very high quality with soft rubber gaskets on the rear that needs to be punctured by the two wires that feed in. The tight seal provided here is far superior to that offered by standard cavity sockets without this feature.



Surface-mounted socket



In-wall socket



Cavity socket

Please follow the installation instructions in *Section 2.5.3*. They also apply to the Mx2wire+ indoor unit.

Preparing and Testing the Two-Wire Cable

In general, Mx2wire+ is used with existing cables (bell wire). When cables have more than two wires, make sure (color coding) that the same cable pair is used for both Mx2wire+ units (see figure). **Approximately 5 mm of insulation** must be stripped from both ends of the two-wire cable.

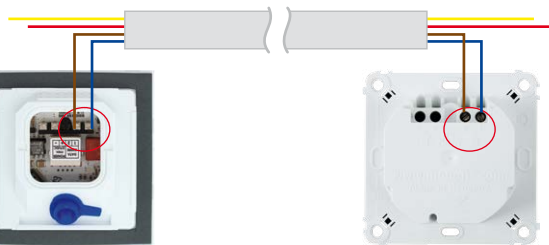

Info Module Mx2wire+

Mx2wire+
indoor unit

Cable with wire-end sleeves (for flexible cores)

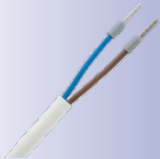

Prior to installation, test the cable connection to ensure that it is functioning properly (if necessary, draw up a test chart).

2.6.3 Installation Using Cavity or In-Wall Socket

1. Prepare the **cavity or in-wall socket**: see *Section 2.5.3*
2. **Screw the two-wire cable to terminals 1 and 2:** The cable does not necessarily need to be attached to the terminal with the same number on both Info Module Mx2wire+ units. The device continues to function if connectors 1 and 2 are swapped.

Connectors 3 and 4 are only assigned if an external voltage source (48-57 V DC) is used.

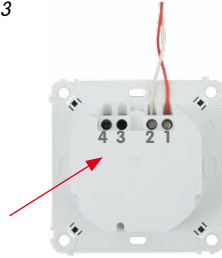

3. **Remove the front panel and frame:** In order to protect the circuit board, the board is attached to the front panel and frame in the original packaging. To continue with the installation, however, you must first separate the housing and board from the panel and frame. Loosen the screw in the front panel and lift the panel forwards.



The screw does not need to be removed completely from the front panel

Now remove the attached frame from the circuit board. Please note that you will need the stainless steel screw in the front panel again later.



Safety Warning

Use this product in compliance with the applicable legal regulations. Electrical systems and equipment may only be installed, modified and maintained by a qualified electrician or under the direction and supervision of a qualified electrician in accordance with the applicable electrical guidelines.



The board is attached directly to the socket using two screws (see figure) or to the wall using the Torx screws

MOBOTIX printed at the bottom

- 4. Insert the housing and circuit board into the socket:** The two cable clamps on the rear of the housing are located at the top. For a cavity socket, make sure you only use the stainless steel screws provided. Using different (larger) screws could damage the circuit board.



- 5. Attach the frame:** Place the selected frame (concave, convex or flat) onto the board and press down gently until it automatically snaps into place. MOBOTIX is printed on the bottom of the frame.



- 6. Insert the panel:** Hook the front panel onto the frame, as shown in the figure, and then press it down.



- 7. Screw the panel on tightly:** Secure the front panel using the panel's stainless steel screw.



2.6.4 Installation With Surface-Mounted Socket

1. Prepare the **surface-mounted socket**: Preparation: Please refer to the figure on the right and use the surface-mounted socket as a template to mark the drill holes. Make sure that the alignment and position of the socket in relation to the two-wire cable are correct (TOP/OBEN arrows).

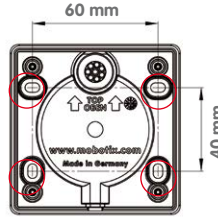

Supplied rubber plug for sealing the two-wire cable:



For cables with 3 to 5 mm diam.



For cables with 5 to 7 mm diam.



For cables with a maximum of eight wires

2. **Feed in the two-wire cable (plus optionally the 48 V connector) and screw on the surface-mounted socket**: Feed the two-wire cable through the opening provided that is sealed with a rubber plug. Use the 8-wire plug for multi-wire cables. You only require two of these wires for Info Module Mx2wire+. The other two plugs with only one opening are ideally suited to insulated, two-wire cables of varying thickness. Now use the four Torx screws to securely fasten the surface-mounted socket to the screw anchors or directly to the (wooden) surface. Please ensure that you only use the existing four drill holes of the surface-mounted socket.



3. **Remove the front panel and frame**: In order to protect the circuit board, the board is attached to the front panel and frame in the original packaging. To continue with the installation, however, you must first separate the board and housing from the panel and frame. Loosen the screw in the front panel and lift the panel forwards.

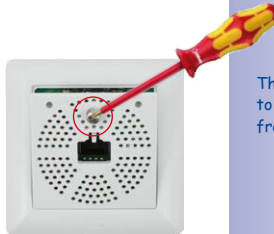

The screw does not need to be removed completely from the front panel!

Now remove the attached frame from the circuit board. Please note that you will need the stainless steel screw in the front panel again later.



The device continues to function if connectors 1 and 2 are swapped



4. **Screw the two-wire cable to terminals 1 and 2:** The cable does not necessarily need to be attached to the terminal with the same number on both Info Module Mx2wire+ units. The device continues to function if connectors 1 and 2 are swapped.

Connectors 3 and 4 are only assigned if an external voltage source (48 V DC) is used.



5. **Insert the housing and circuit board into the surface-mounted socket:** The two cable clamps on the rear of the housing are located at the top. Attach the housing and board to the surface-mounted socket by fastening the four stainless steel screws in the four existing drill holes.

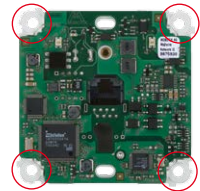

6. **Attach the frame:** Place the selected frame (concave, convex or flat) onto the board and press down gently until it automatically snaps into place. MOBOTIX is printed on the bottom of the frame.



7. **Insert the panel:** Hook the front panel onto the frame, as shown in the figure, and then press it down.

First hook panel on underneath, then press down the top



8. **Screw the panel on tightly:** Secure the front panel using the panel's stainless steel screw.



2.6.5 Function of Mx2wire+ Status LEDs

Each Mx2wire+ unit has two status LEDs (green and orange), which provide information on the current state of the PoE power supply and on the transfer of data. The LEDs can either light up continuously (ON) or they can blink (BLINK).

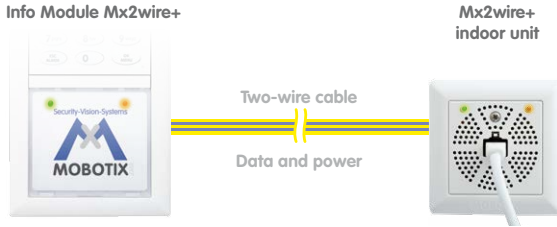

Green LED	Orange LED	Green LED	Orange LED
ON	ON	ON	ON
Power is supplied to the outdoor station	Network connection to the outdoor station has been established	Power is supplied to the indoor unit	Network connection to the switch has been established
BLINK	BLINK	BLINK	BLINK
never	Data is transferred to the outdoor station	Outdoor station is receiving power (if connected)	Data is transferred from the indoor unit

Note

The two **status LEDs (orange, green)** in the outdoor station's Info Module Mx2wire+ are only active for test purposes for the first 15 minutes after the power supply has been established. After the LEDs have gone out, they can be reactivated by interrupting the power supply for a short time.

2.7 Connecting External Devices to the Door Station

A power relay can be connected to the door station via an external power supply (max. 24 V AC/DC) for the purpose of switching different types of devices (for example, outside lights, garage doors, alarm systems, additional doorbells and so on). Connection is established either via the MOBOTIX IO Module (accessory) or the access module (KeypadRFID/BellRFID).

The T25 camera software is used to configure the switching of external devices and can be accessed via a standard web browser such as Internet Explorer. For additional information on this topic, see the *T25 System Manual Part 2*.

2.7.1 Using the IO Module

Connect the IO Module to the camera module T25-CamCore via MxBus, which connects it to the network. It has eight physical signal inputs that allow it to distinguish between a pending full-wave and half-wave if an external AC voltage source has been connected. This makes it possible to connect two switches to each signal input terminal so that 16 button inputs are made available. The inputs can be used for, e.g., bell buttons. The outputs can be used for external devices such as a doorbell, or for outdoor lights or garage door openers (via a power relay).



Installing the board and Ethernet connector: see *Section 2.3.5*

IO Module circuit diagram with 16 button inputs and 3 signal outputs (connected with a relay here)

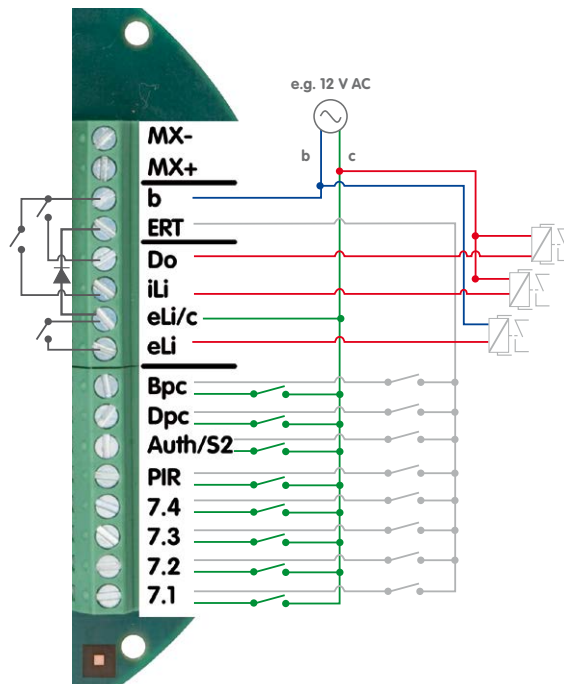

Terminal Connector Functions (External Devices and Third-Party System)

In addition to general technical specifications for the signal inputs and outputs, the table also shows the precise layout of the 16-wire terminal connector when the external devices are modules from a third-party system.

Board	General Function	Function of Third-Party System	Comment	
MX-	MxBUS-	MxBUS	Direct connection to camera module	
MX+	MxBUS+			
b	Gnd	Ground	Reference potential	
ERT	HW	Signal from eLi/c (half-wave rectified)	Floor call when c fits eLi/c	
3 x signal outputs	Do Max. switching voltage: 48 V AC, 48 V DC Max. current: 2 A Max. load: 60 W	Door opener	Relay switches b (door opener still connected to c)	
		ili	Internal lights of third-party modules	Relay switches b (modules each still connected to c)
		eLi/c	Control for external light (e.g., over the entrance door)	Isolated relay (NO type)
		eLi		
		8 x signal inputs	Bpc Max. input voltage: 24 V AC, 24 V DC Min. input voltage: 5 V AC, 5 V DC Min. current: 2 mA	Door lock switch (Bolt Position Contact)
Dpc	Door contact (Door Position Contact)			Contact switches c
Auth/S2	Transponder/Fingerprint			Module switches c
PIR	PIR module/motion sensor			Module switches c
7.4	Bell button 4			Bell switches c (full-wave) floor call switches ERT (half-wave)
7.3	Bell button 3			
7.2	Bell button 2			
7.1	Bell button 1			

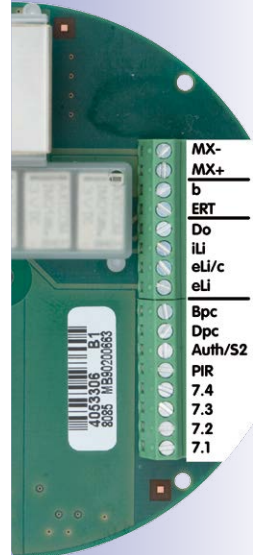

Example: Connecting Up to Four Bell Buttons

Connect bell buttons:

- First wire to terminals 7.1 to 7.4 (1 to 4 bell buttons)
- Second wire to power supply

Connect power supply:

- First wire to terminal b
- Second wire to bell buttons

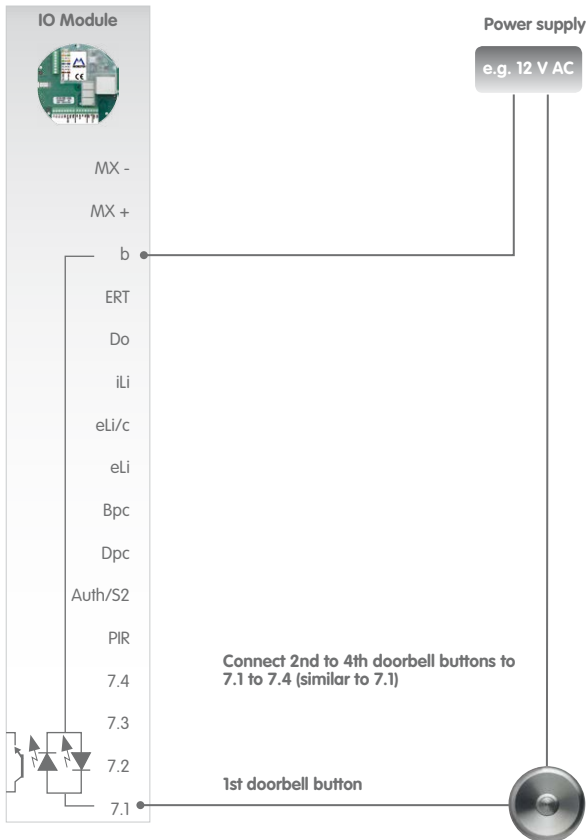

2.7.2 Using the Signal Outputs of the Access Module (KeypadRFID/BellRFID)

If the T25 door station is used with the MX-DoorMaster and a standard door opener, all the access module connectors apart from the MxBus connector remain unused (see Section 2.5.2, Version 1).

Example: Connecting a Lamp Supplied With 230 V (KeypadRFID/BellRFID)

Connect power relay (for lamp):

- First wire of control circuit (A1 terminal of relay) to COM terminal
- Second wire of control circuit (A2 terminal of relay) to OUT A terminal
- Power circuit for lamp (to be connected only by a qualified electrician)

Connect external power supply (for relay control voltage, e.g. 12 V AC):

- First wire to OUT B terminal
- Second wire to COM terminal

Connect lamp:

- First wire to power relay
- Second wire to 230 V



T25 with KeypadRFID



T25 with BellRFID

Please note that you can currently attach **only one access module** (i.e., either KeypadRFID or BellRFID) to an IP Video Door Station.

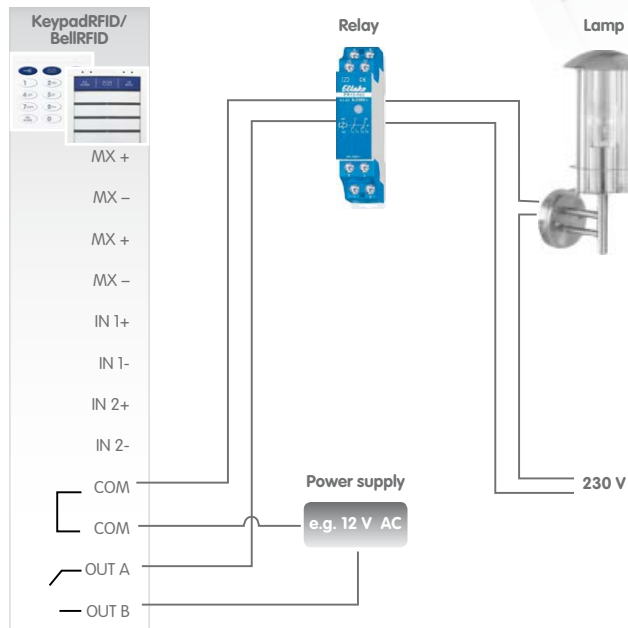

Example: Connecting Up to Two Bell Buttons to KeypadRFID

Connect first bell button:

- First wire to IN1+ terminal
- Second wire to IN1- terminal

Connect second bell button:

- First wire to IN2+ terminal
- Second wire to IN2- terminal

Note

The voltage required by the bell buttons (low voltage) is supplied by the access module. No additional power supply is necessary.

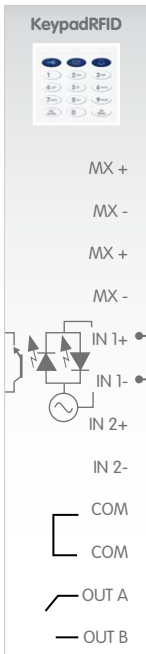

1st doorbell button



Connect 2nd doorbell button to IN 2+ and IN 2- (similar to 1st doorbell button)

2.8 Finishing the Installation

2.8.1 Checking the Wiring and Activating Theft Protection

After installing and connecting the door station, you will need to test the power supply to the individual modules and the MX-DoorMaster.

Connect all the installed components (T25 outdoor station, MX-DoorMaster, door opener/Mediator, door sensors, light and so on) and **connect the power supply** (switch on PoE switch/router and all power supply units used). The MOBOTIX IP Video Door Station starts up after the power supply is connected. The entire system starts up.

The buttons on the T25-CamCore light up for four seconds. Without pressing a button, wait until the lights go out after a few minutes and then light up again.



Notes

The blinking of the green LED on the access module and MX-DoorMaster indicates that data is communicated between the individual modules via Mx-Bus but the data communication is still unencrypted. After the system is started up (see the *T25 System Manual Part 2*), the green LED lights up continuously (MxBus data communication is encrypted).

The LED on the access module lights up red when the communication of data via MxBus is interrupted (for example, if the camera module stops working).

Checking the Wiring

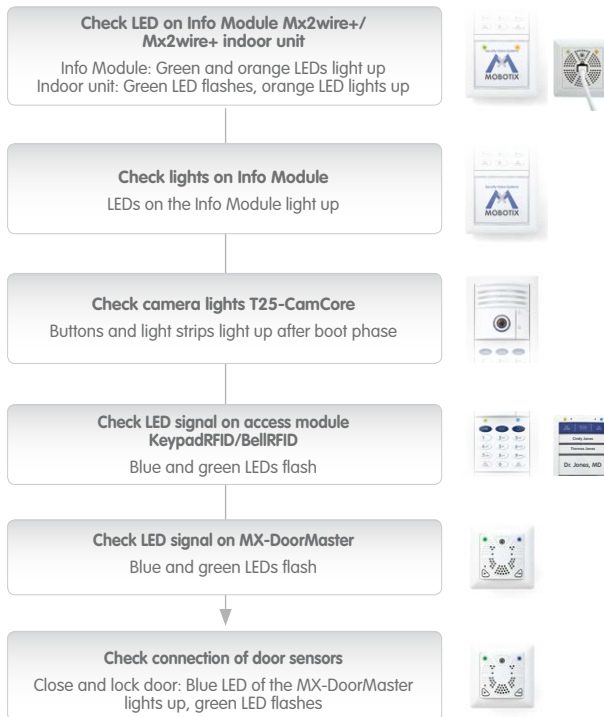

Test sequence from top to bottom; unavailable modules are skipped

When a battery is almost completely discharged, the red LED on the MX-DoorMaster lights up first (for approximately 15 min.)

Activating Theft Protection

Test the theft protection module by pressing and holding down the two buttons on the MX-DoorMaster until the blue LED blinks. This deactivates the anti-theft protection in the frame for 90 seconds (see *Section 2.4.7*).

Use the special key to release the module above the mechanical anti-theft protection lock and turn the red button to the 'closed lock' symbol (see *Section 2.3.7*). Insert all the modules securely back into the frame. The modules can only be removed now after deactivating the anti-theft protection.



Before operating the door station, the batteries in the MX-DoorMaster must be fully charged (maximum charging time: 12 hours). Finish the installation with *Section 2.8.2*, «*Configuring the MX-DoorMaster*».

2.8.2 Configuring the MX-DoorMaster

Before using the MX-DoorMaster, it is essential to configure the signal output option to be used (see Section 2.5.2, «Connection Diagrams for Door Opener Versions»).

Three Options Are Available

Option 1: Power Supply From MX-DoorMaster Battery (Self-Powered)

The door opener is supplied with a pulsed 12 V voltage (max. 10 W) from the battery. This state is signaled by a green LED in configuration mode. As this is the factory default setting, no further configuration is required for this connection option.

Option 2: Power Supply From External Power Supply Unit (Internal Relay Function)

The relay integrated into the MX-DoorMaster switches an external voltage that powers the connected door opener. This is signaled by a red LED in configuration mode. Configuration is required here (see below).

Option 3: Self-Locking Mediator Door Lock Including UPS Via Battery Pack

A DC control signal is switched to the control input of the Mediator (special door opener that keeps the door permanently locked). This is signaled by a blue LED in configuration mode. Configuration is required here (see below).



Self-powered (standard version)

Internal relay function

Mediator

The signal output option is set on the MX-DoorMaster in three steps as part of the initial setup.

Step 1: Press both buttons at the same time for 5 seconds (until double beep)

You are now in administration mode (red LED turns off shortly every 3 seconds).



Step 2: Press door opener button (right) to configure the signal output option

You can switch between signal output options 1 to 3 by pressing the right button repeatedly. The flashing pattern of the blue LED signals the currently selected setting.

- Blue flashing 1x every 3 seconds: Self-powered
- Blue flashing 2x every 3 seconds: Relay
- Blue flashing 3x every 3 seconds: Mediator



Step 3: Press both buttons at the same time for 5 seconds (until double beep)

The setting has been saved and you are exiting administration mode.



Notes

Test that the MX-DoorMaster is functioning by pressing and holding the door opener button for 3 seconds. It should now be possible to open the door from the outside.



To demonstrate our confidence in the quality of our products, MOBOTIX cameras have been used to capture all images that appear in this manual.

Manufacturer

MOBOTIX AG
Kaiserstrasse
67722 Langmeil
Germany

Phone: +49 6302 9816-103

Fax: +49 6302 9816-190

www.mobotix.com

sales@mobotix.com

Registration Office: Kaiserslautern Local Court

Registration Number: HRB 3724

Tax Office: Worms-Kirchheimbolanden, Germany

Tax Code: 44/676/0700/4

VAT ID: DE202203501

You can find the latest version of this and other documents (e.g., declarations of conformity) at www.mobotix.com in the **Support** section.



Technical specifications subject to change without notice!



Part 1: System Overview and Installation

Installation and Cabling
(for the **Installer**)

Part 2: Start-Up and Configuration

Software and Network
(for the **System Administrator**)

5 MP
Sensor

MxLEO



vPTZ



MxBus

USB

+50°
-30°

IP65



Innovations - Made in Germany



The German company MOBOTIX AG is known as the leading pioneer in network camera technology and its decentralized concept has made high-resolution video systems cost-efficient.

MOBOTIXAG • D-67722 Langmeil • Phone: +49-6302-9816-103 • Fax: +49-6302-9816-190 • sales@mobotix.com